

1

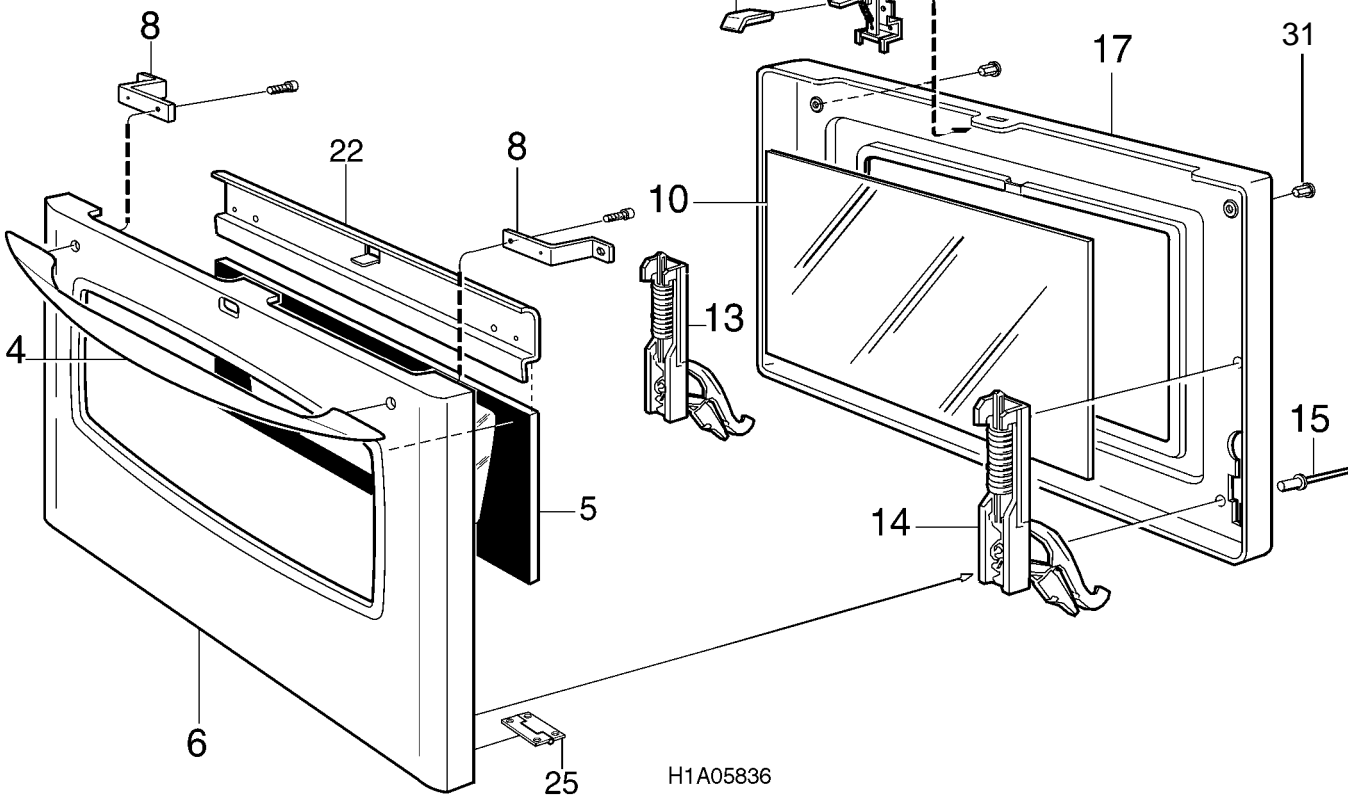

H1A05836