

Electrolux

SPARE PARTS LIST

Split RAC
(Cool only, Heat & Cool)
4150



Item	PNC	ELC	Brand	Model	Market
A	956004722	00	Electrolux	ESV18CRR-B5	THE
A	956004746	00	Electrolux	ESV18CRR-B5I	THE
A	956004770	00	Electrolux	ESV18CRR-B5E	THE

SAFETY WARNING

Always turn off and unplug the machine before detaching any parts.

When servicing machines, do not remove ANY detachable parts while the machine is powered. The reason is internal faults may cause shorts to components that are normally at low voltage presenting a shock hazard.

Electrolux Thailand Co.,Ltd.
1910 Electrolux Building
New Petchburi Rd. Bangkok
Huaykwang
Bangkok , 10310
Tel : +662 725 9000

Publication-No
2000421

Split RAC (Cool only,
Heat & Cool)

Model : ESV18CRR-B5I
PNC : 956004746 00

Ex. View Drawing
(Indoor Unit)

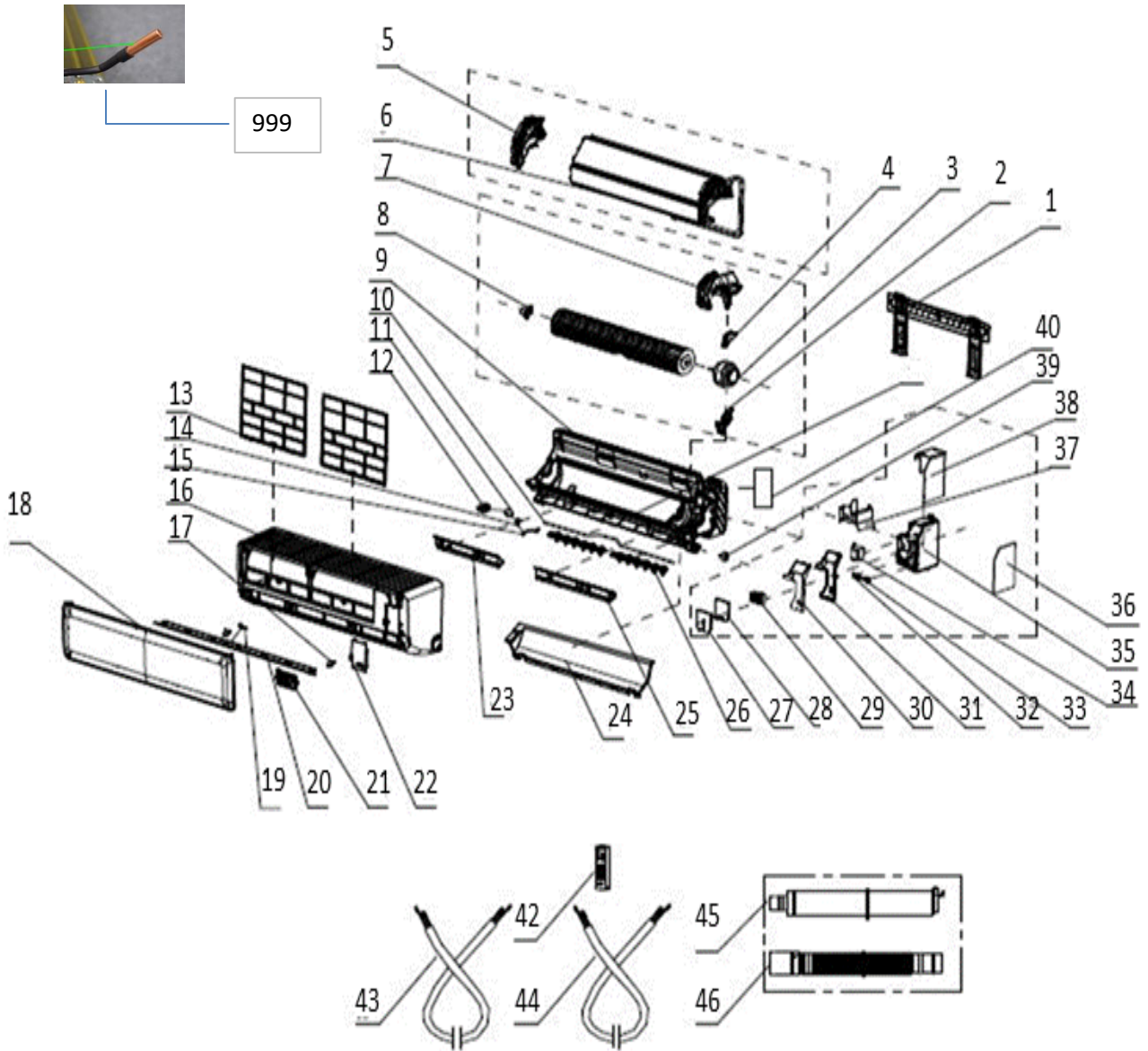

Item	PNC	ELC	Brand	Model	Market
A	956004746	00	Electrolux	ESV18CRR-B5I	THE

Pos.	Part No.	Description	
1	11321003000041	MOUNTING PLATE ASSEMBLY	1
3	11230005000045	INDOOR FAN MOTOR	1
4	11320087000030	THE MOTOR HOLDER	1
4	11320087000031	THE MOTOR HOLDER	1
5	11320015000138	EVAPORATOR LEFT SIDE CARRIAGE	1
6	11224003000730	EVAPORATOR ASSEMBLY	1
7	11320052000043	MOTOR COVER	1
8	11220551000003	BEARING ASSEMBLY	1
9	11320001000240	CHASSIS	1
13	11220508000147	FILTER	2
16	11320002000303	MEDIUM FRAME	1
17	11320096000104	SCREW COVER	2
18	13220598000747	PANEL	1
19	11320080000007	AIR LOUVER	1
20	11320005000379	AIR LOUVER	1
21	11222014000605	DISPLAY BOARD ASSEMBLY	1
22	11320076000057	MEDIUM FRAME WIRING COVER	1
23	11328030000012	CHASSIS FOAM B	1
24	11328003000120	CHASSIS FOAM A	1
25	11328030000014	CHASSIS FOAM D	1
26	11320017000122	LEFT-RIGHT SWING BLADE	2
28	11320058000068	COVER OF ELECTRIC CONTROLLER BOX	1
29	11330037000020	TERMINAL BOARD	1
30	11321020000038	COVER OF E CTRL BOX SHEET-METAL	1
32	11320010000045	WIRE CLAMP	1
35	11320057000083	CONTROLLER BOX	1
36	13222002002622	MAIN PCB	1
39	11230002000071	STEP MOTOR	1
40	11320084000014	PIPE CLAMP	1
41	11320135000017	VOLUTE	1
42	11222001000869	REMOTE CONTROLLER	1
45	11220506000009	WATER OUTLET ASSEMBLY	1
46	11320020000008	DRAINING PIPE	1
999	11329013000103	INTEGRATED TEMPERATURE SENSOR	1

ESV18CRR-B5I
PNC956004746 00

Model : ESV18CRR-B5E
PNC : 956004770 00

Ex. View Drawing
(Outdoor Unit)

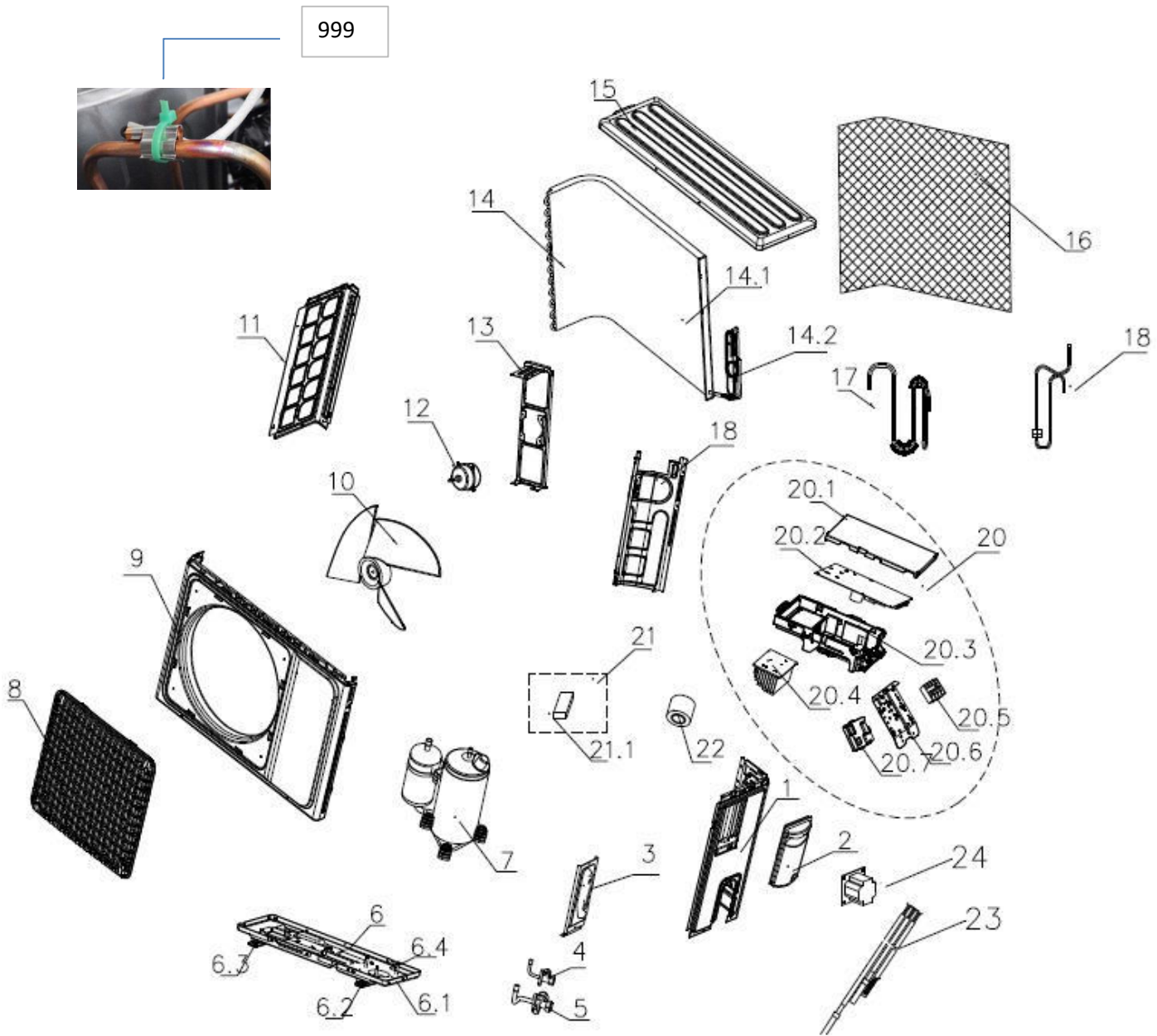

Item	PNC	ELC	Brand	Model	Market
A	956004770	00	Electrolux	ESV18CRR-B5E	THE

Pos.	Part No.	Description	
1	11321007000306	RIGHT SIDE PANEL	1
2	11320101000033	E-PARTS COVER	1
3	11321031000027	VALVE PLATE	1
4	11325042000030	STOP VALVE	1
5	11225517000036	STOP VALVE	1
6	112230030000331	COMPRESSOR ASSEMBLY	1
7	112215020000464	CHASSIS ASSEMBLY	1
7.1	11321014000145	CHASSIS	1
7.2	11321023000019	BASE FOOTING	2
7.3	14731005000042	BOLT	3
8	11320026000062	PANEL GRILLE	1
9	11321005000107	PANEL	1
10	11321006000113	LEFT SIDE BOARD	1
11	11321009000057	TOP COVER	1
12	11320009000063	AXIAL FLOW FAN	1
13	11230004000420	MOTOR	1
14	11321002000040	MOTOR SUPPORT	1
15	11224004001790	CONDENSER ASSEMBLY	1
15.1	11224006000447	CONDENSER ASSEMBLY	1
15.2	11225506001989	CAPILLARY ASSEMBLY	1
16	11321022000222	REAR GRILLE	1
17	11321025000059	PARTITION BOARD	1
18	11330034000020	REACTOR	1
19	11222004001046	MAIN CONTROLLER	1
19.2	11320057000101	CONTROL BOX	1
19.3	11222031001154	MAIN CONTROL BOARD	1
19.4	11320058000081	CONTROL BOX COVER	1
19.6	11321015000071	E-PARTS BRACKET	1
19.7	11330037000171	TERMINAL BOARD	1
19.8	11329031000067	HEAT RADIATOR	1
20	11325020001652	DISCHARGE PIPE ASSEMBLY	1
21	11225504000623	SUCTION PIPE ASSEMBLY	1
22	11219005000203	ACCESSORY BAG	1
22.1	14618079000002	PUTTY	1
23	11320022000019	PLASTIC TIE	1
999	11329013000105	DISCHARGE TEMP SENSOR	1

ESV18CRR-B5E
956004770 00

Model : ESV18CRR-B5I
 PNC : 956004746 00

Ex. Wiring
 (Indoor Unit)

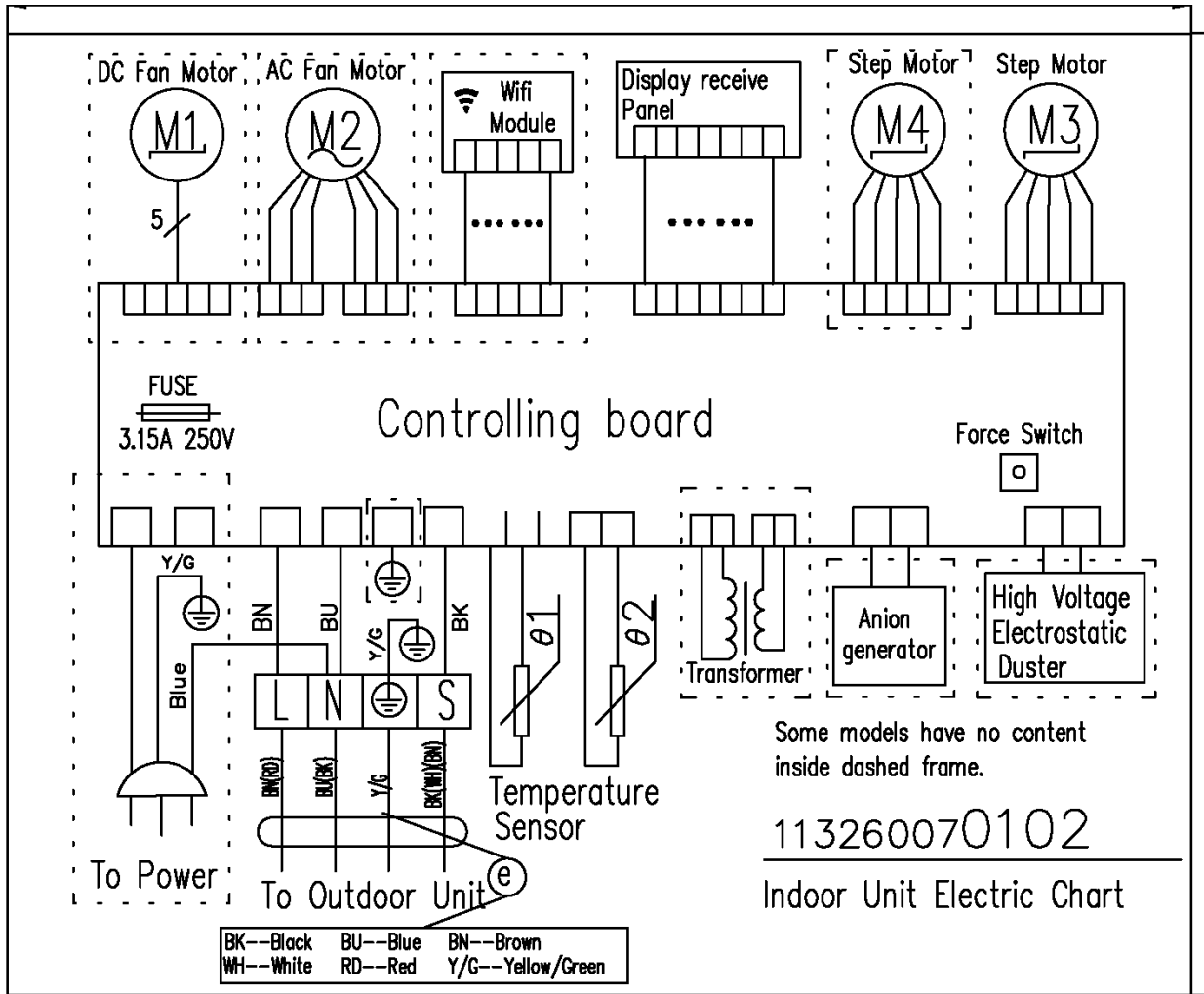

Model : ESV18CRR-B5E
 PNC : 956004770 00

Ex. Wiring
 (Outdoor Unit)

