

320

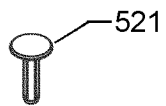

521

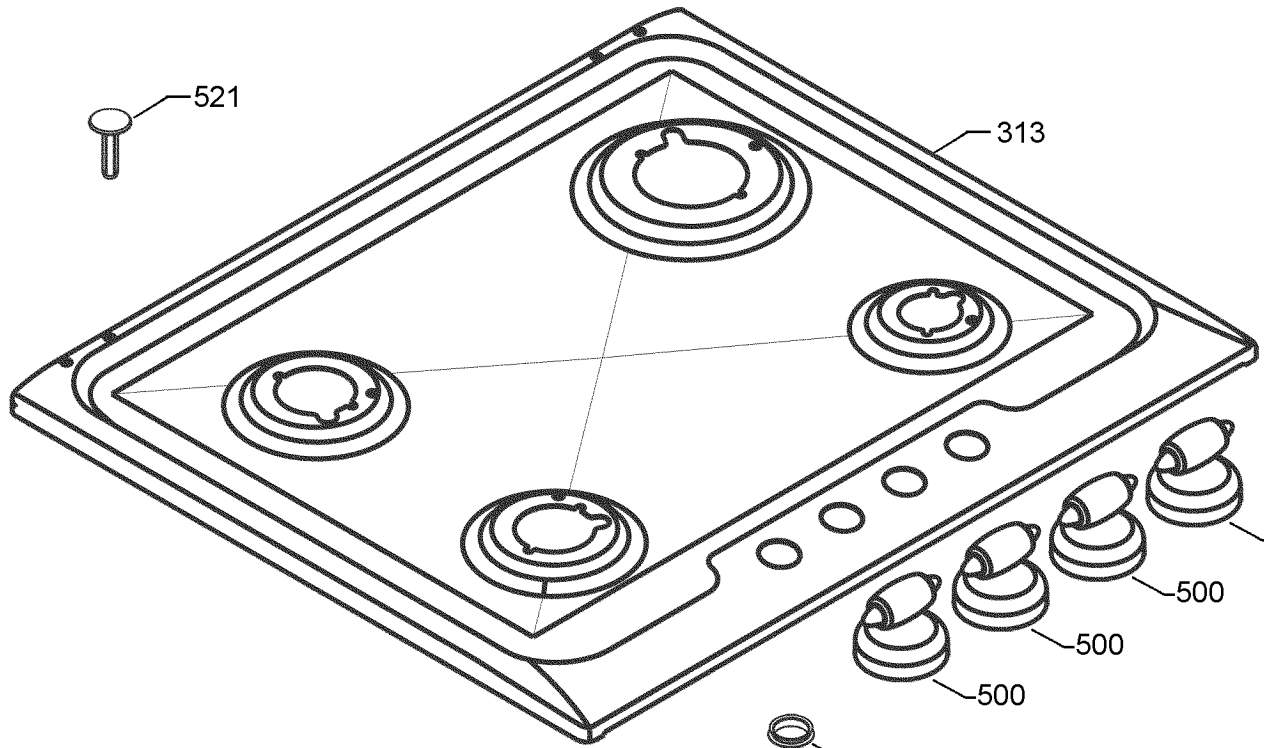

313

500

500

500

500

500

130

9493050965