

320

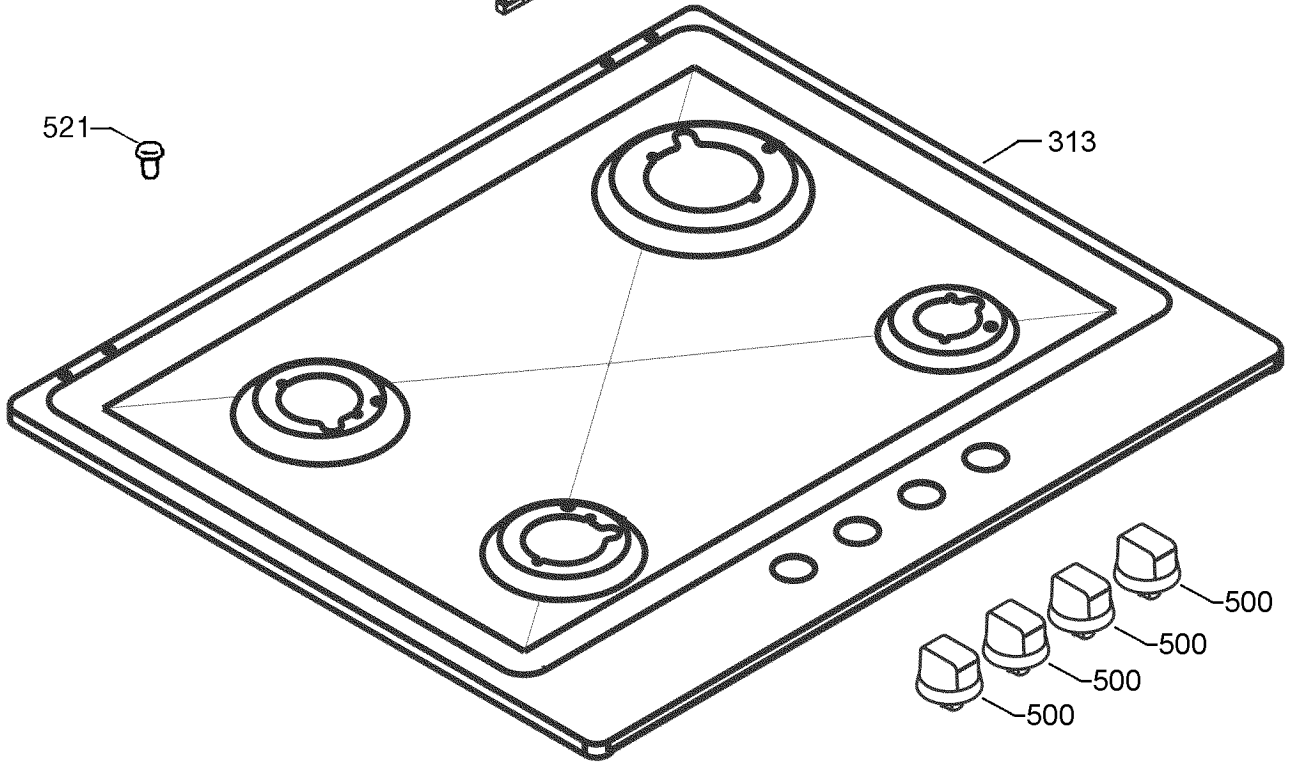

521

313

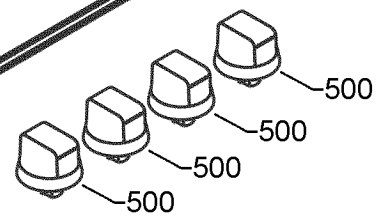

500

500

500

500

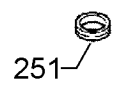

251