

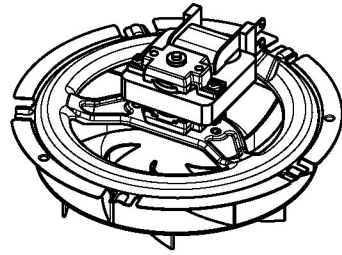

522



510V



518V

∅ 513A

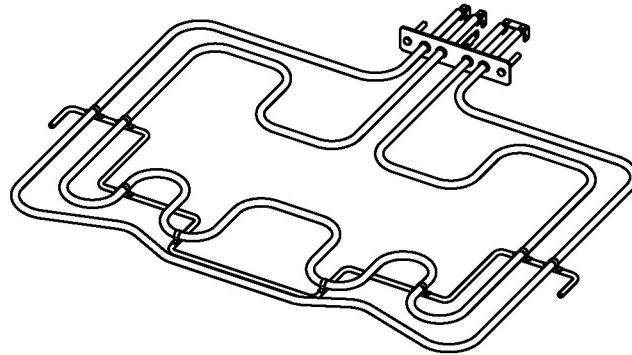
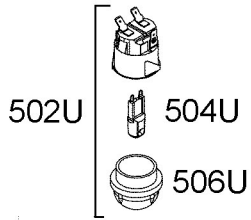

500U



522C

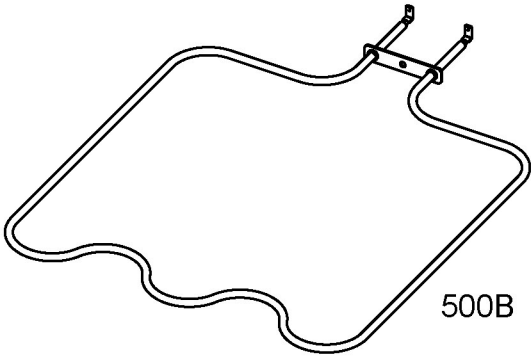

500B

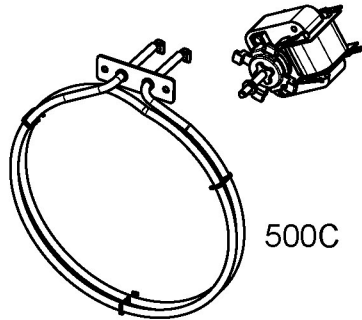

500C



510C



530

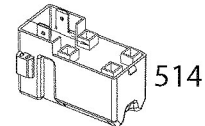

514

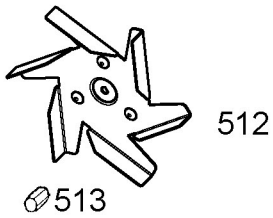

512

∅ 513