

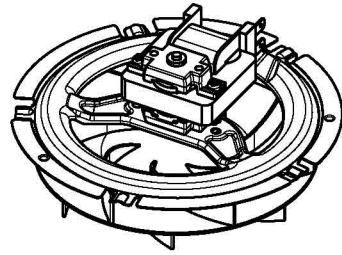

522



522A



510V

Ø 513A

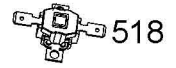
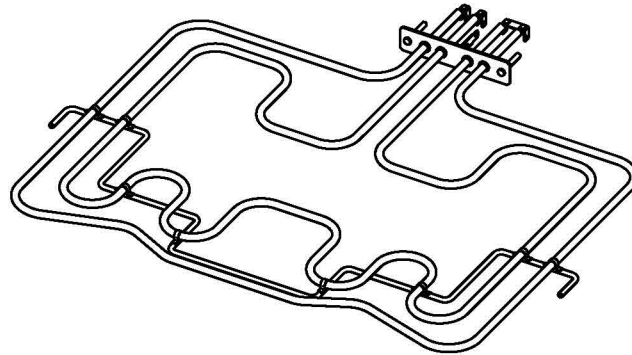
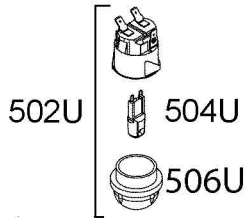

500U



522C

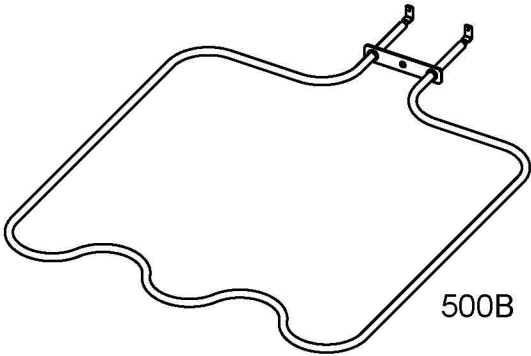

500B

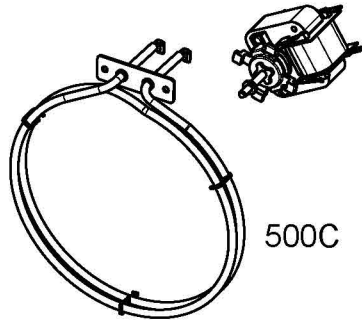

500C



510C



530

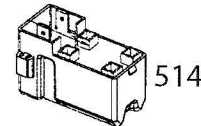

514

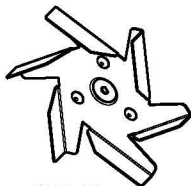

512

Ø 513