

408T

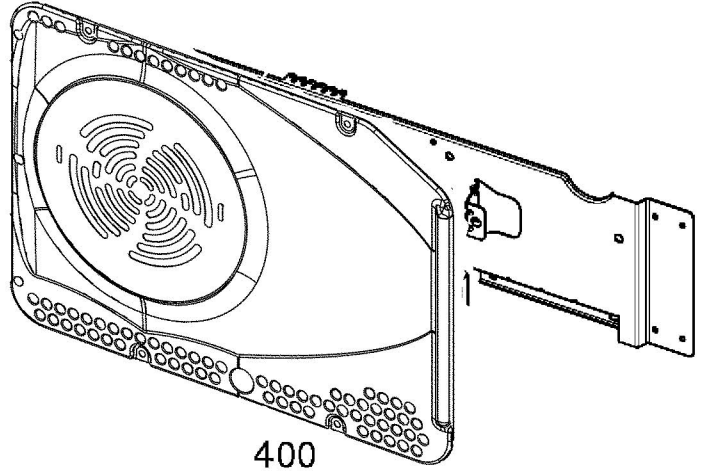
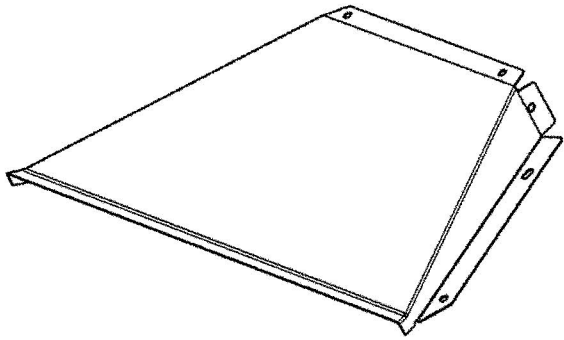

402

400

416

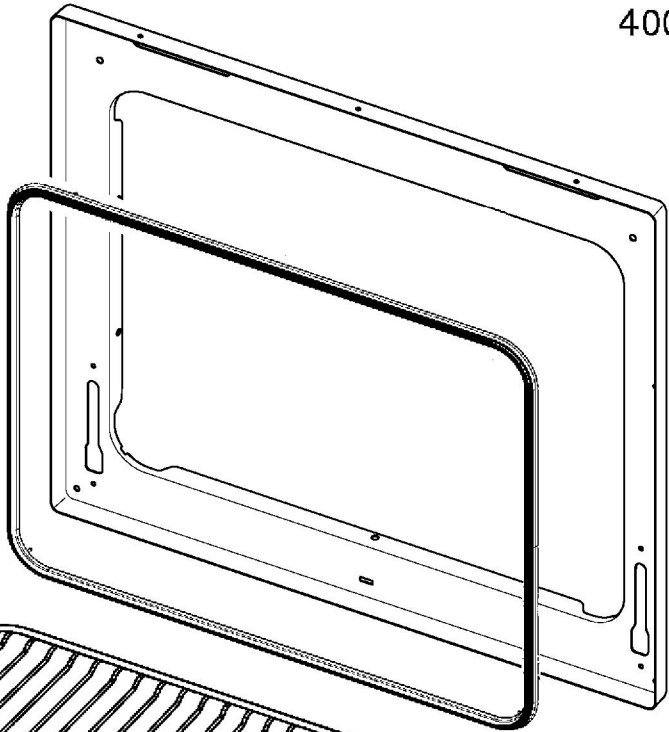

414

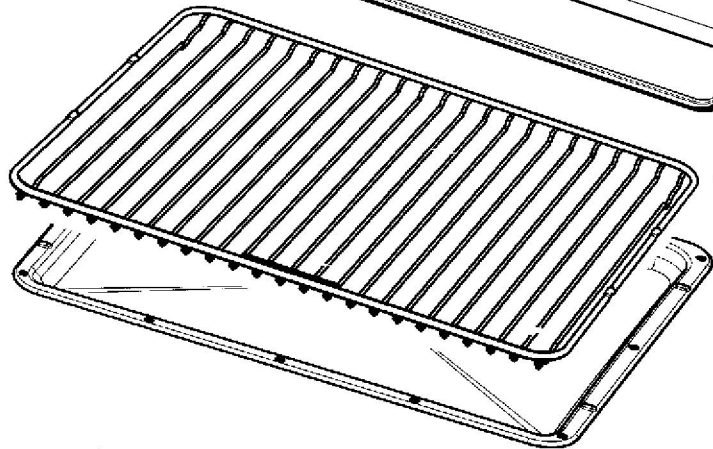

430

432B