

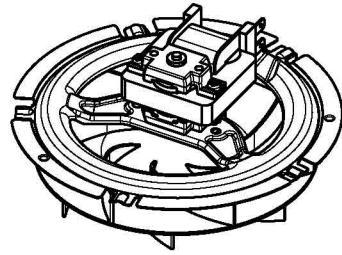

522



510V



518V



522A

Ø 513A

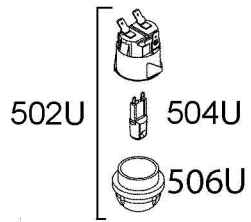

502U

504U

506U

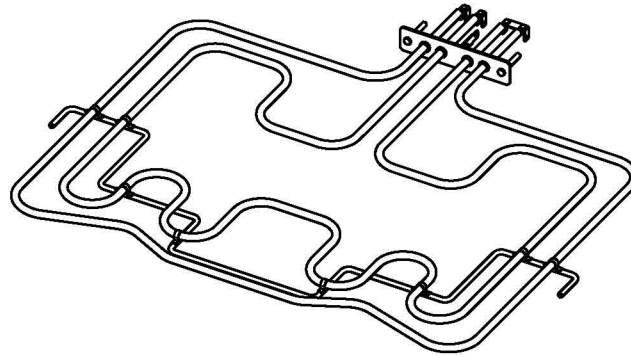

518

500U



522C

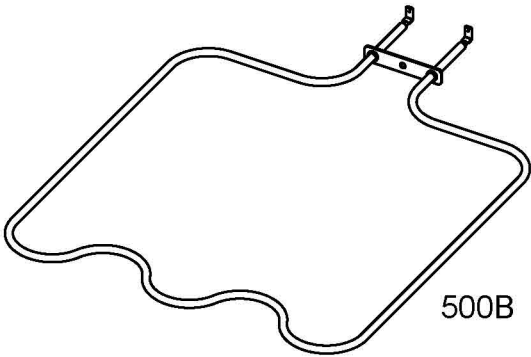

500B

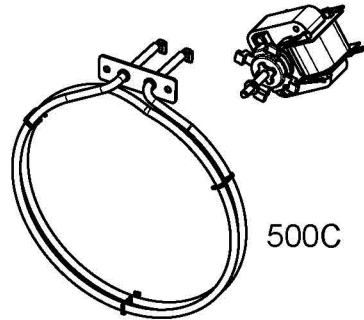

510C

500C



530

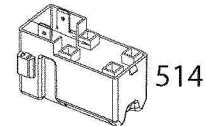

514

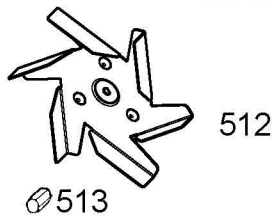

512

Ø 513