

Will be fixed on the inferior side of the chimney, between the chimney and oven.

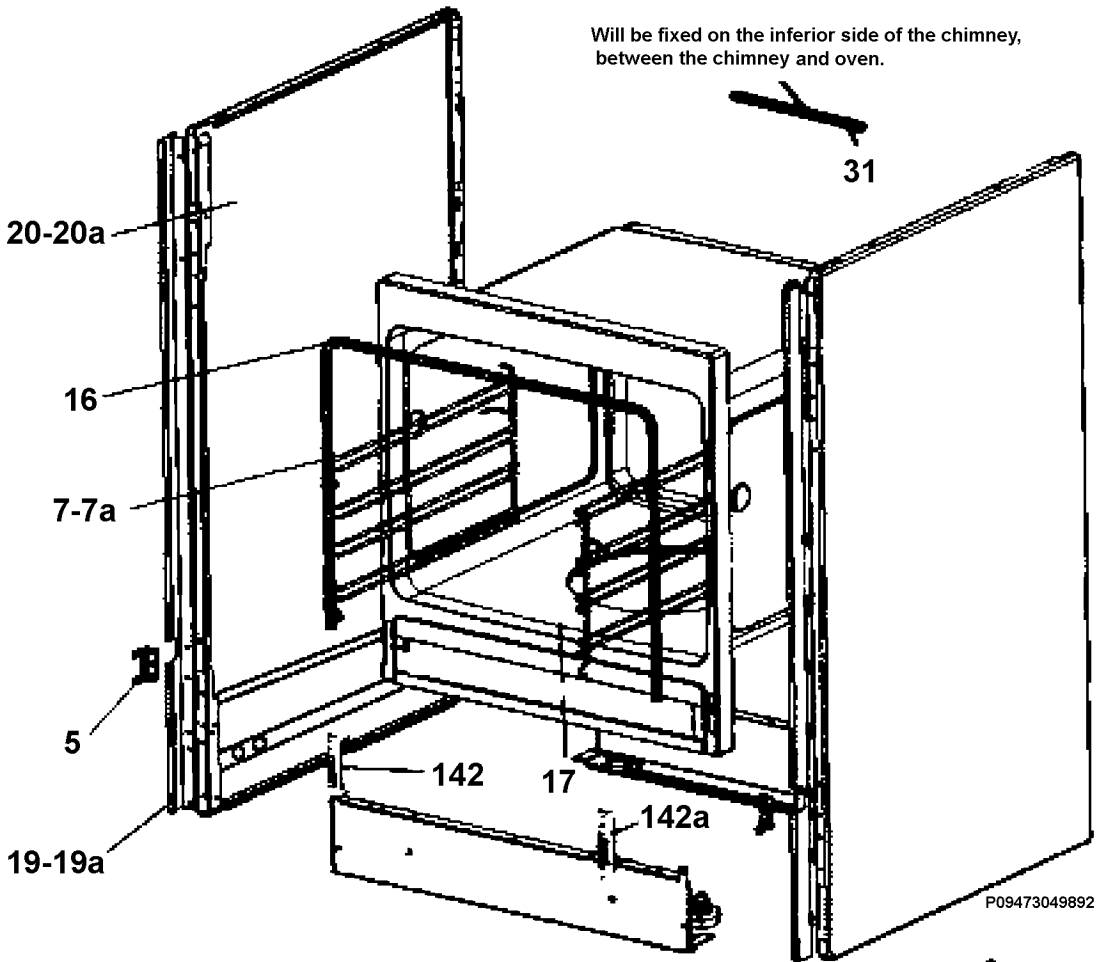

P09473049892

