

Will be fixed on the inferior side of the chimney,  
between the chimney and oven.

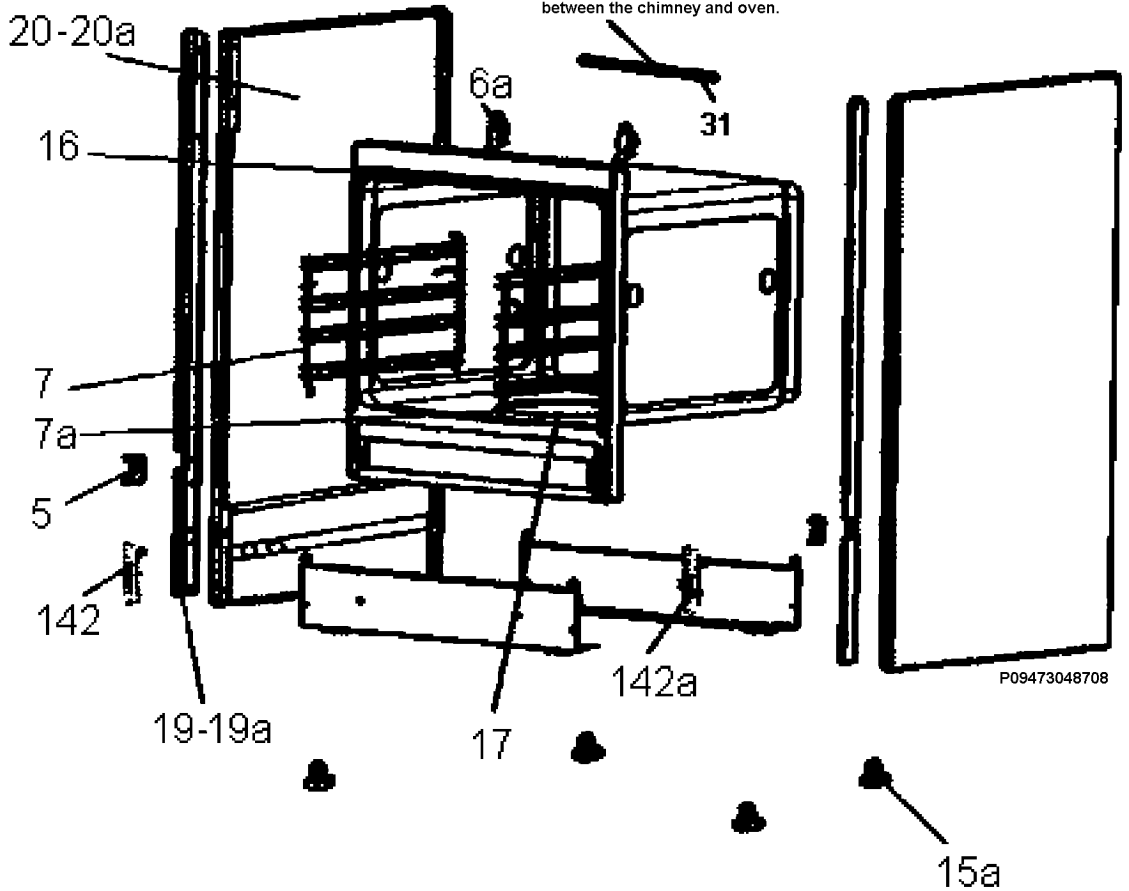

P09473048708