

# MISCELLANEOUS

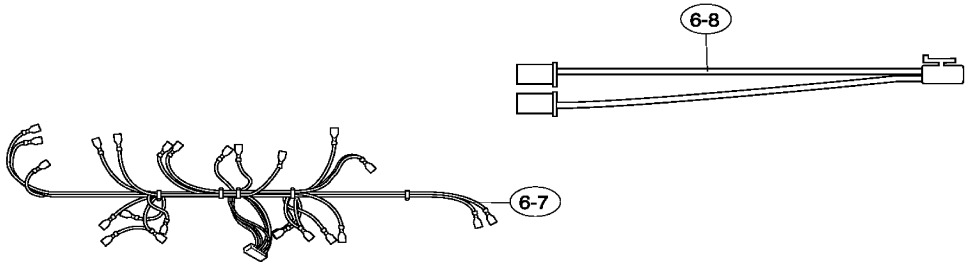

Actual wire harness may be different from illustration.

# ACCESSORIES

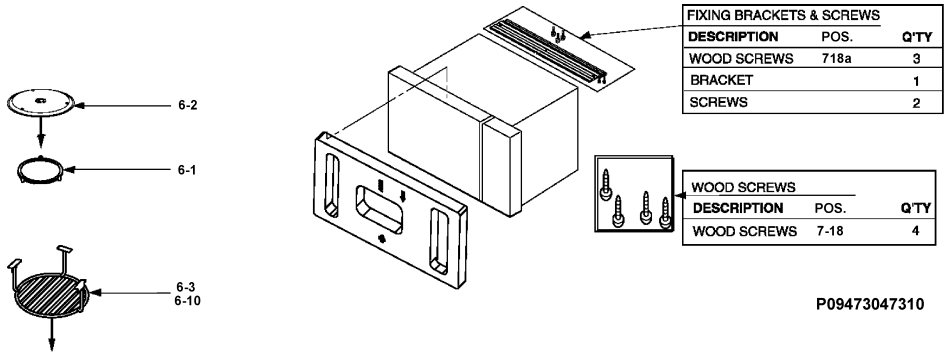

P09473047310