

22

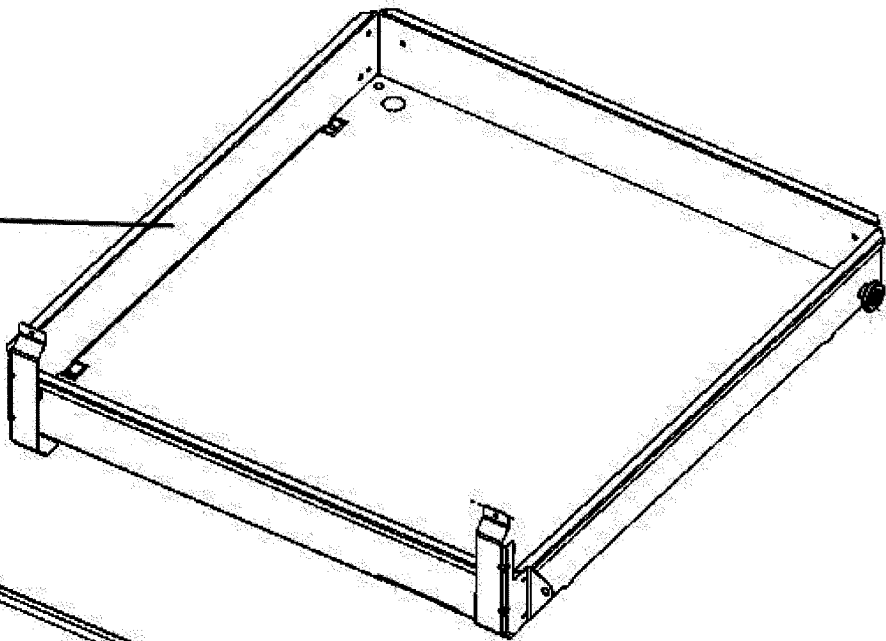

23

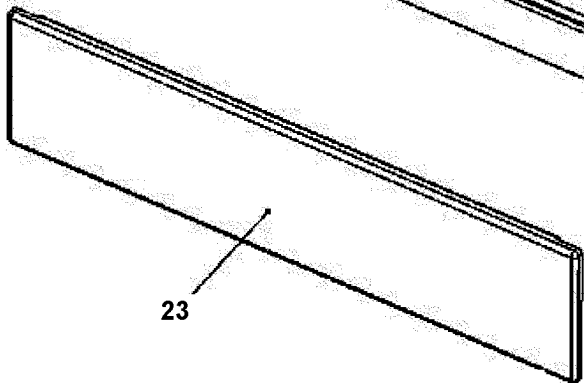

P09473044513