

33a

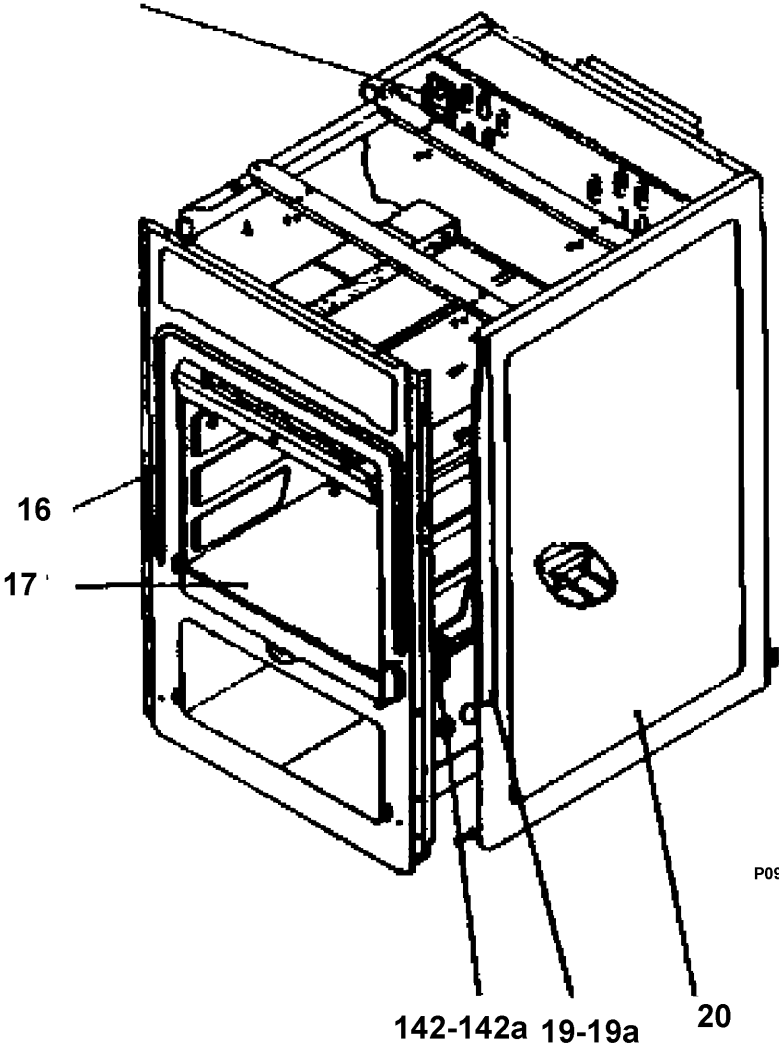

P09473041860