

22

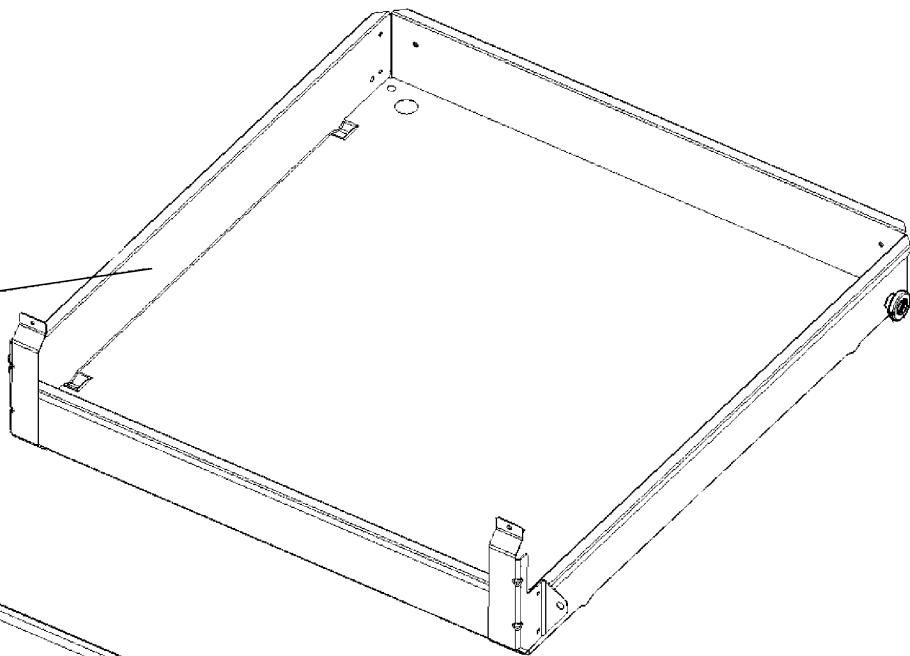

23

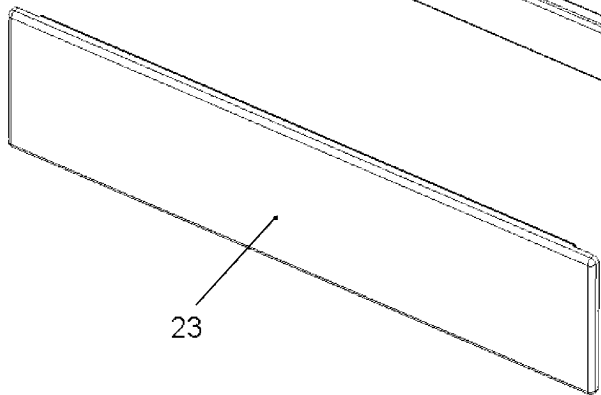

P09473016524