

153

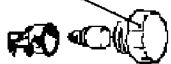

169

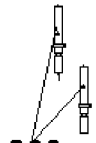
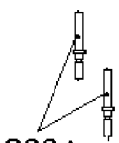

266 A

266 B



252

166

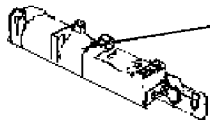

254

262

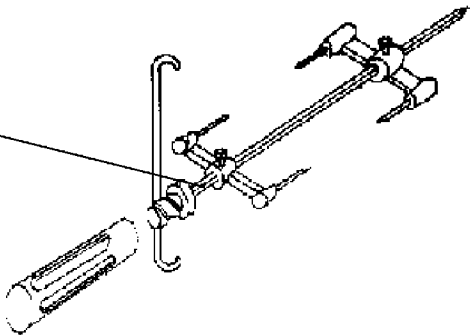

256