

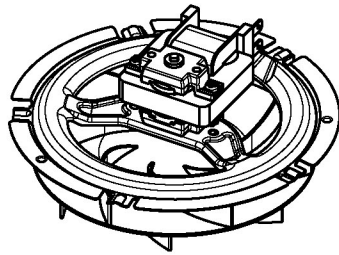

522



510V



518V

∅ 513A

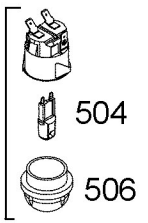

502

504

506

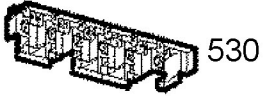

530

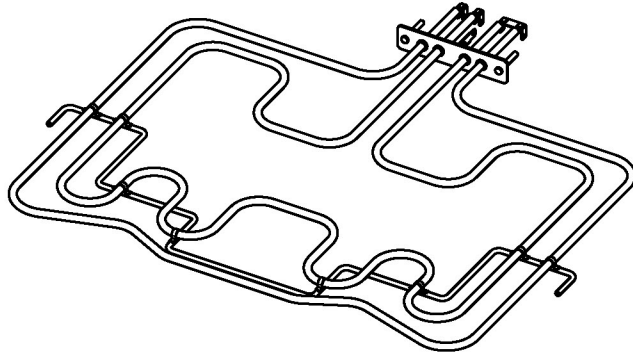

500U



522C

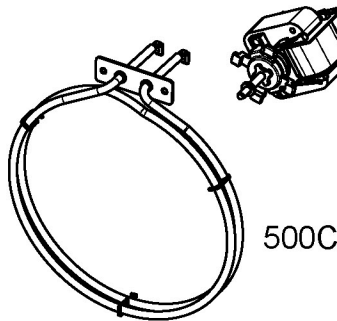

500C

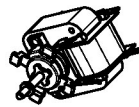

510C



522A

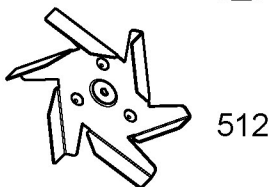

512

∅ 513

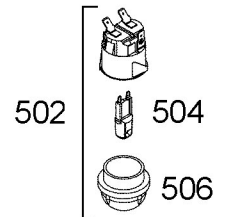

502

504

506