

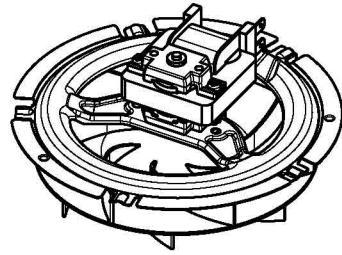

522



510V



518V



522A



513A



520

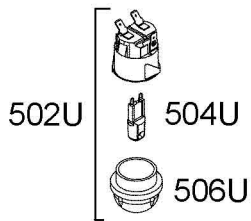

502U

504U

506U

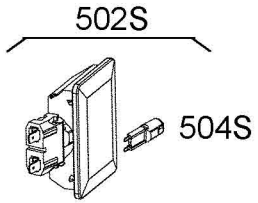

502S

504S

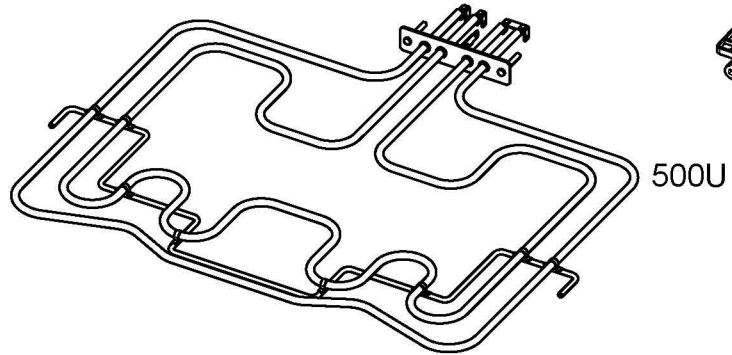

500U



518T

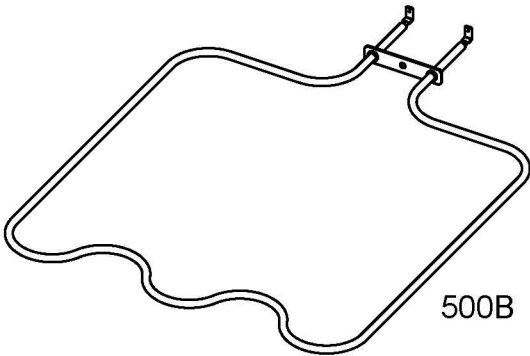

500B



518O

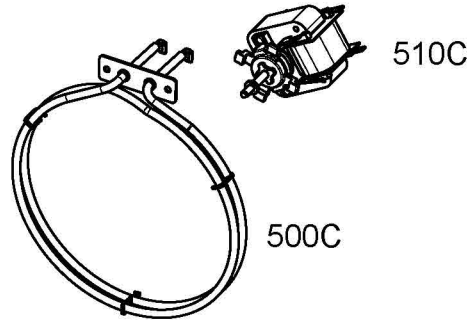

510C

500C



522C

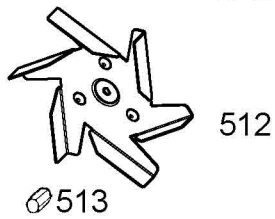

512

513