

300

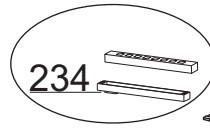
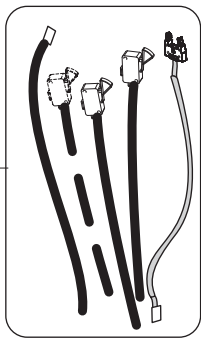

120

67B

252

254



253

107

154

114

60

67A

154

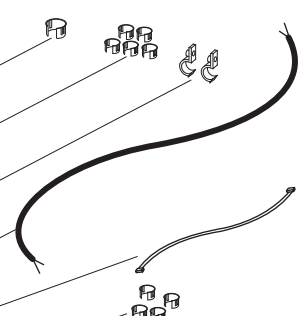

167

16

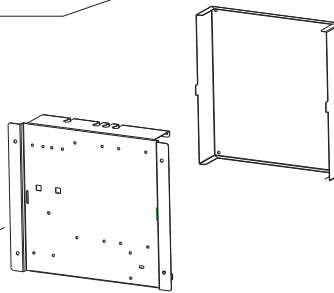

462

67B

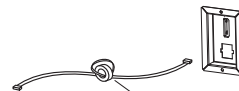

14

151

38

151

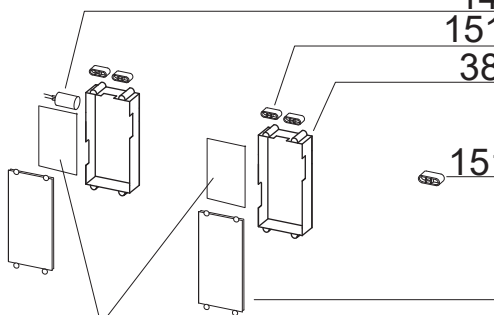

166A

166B



208

19

477

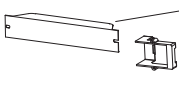

660

