

86



195



100

26

250



6



37



9

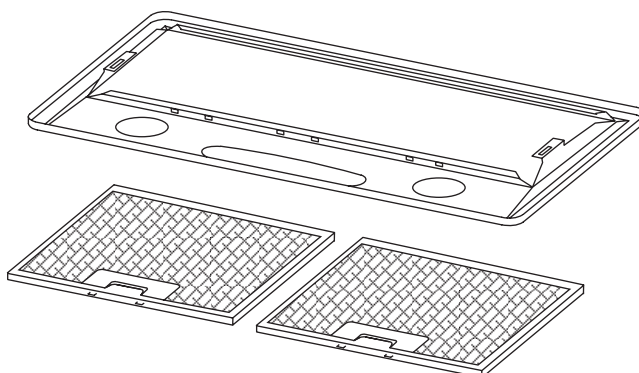

5