

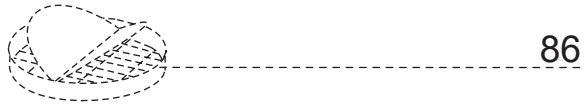

58



86



474

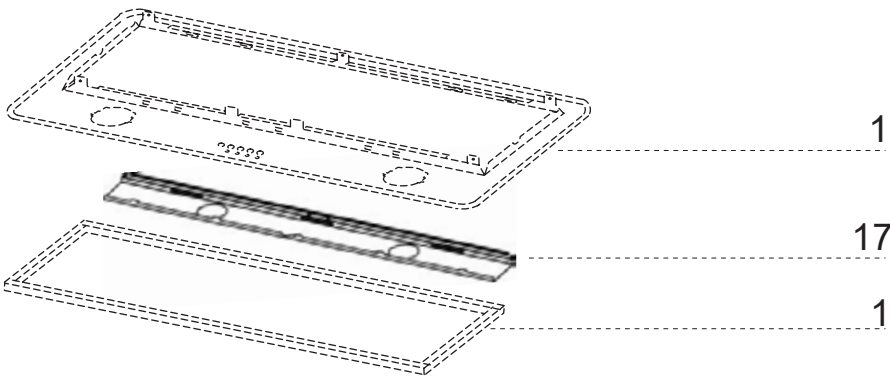

1

17

1

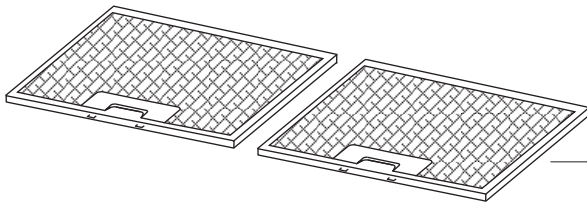

9