

399

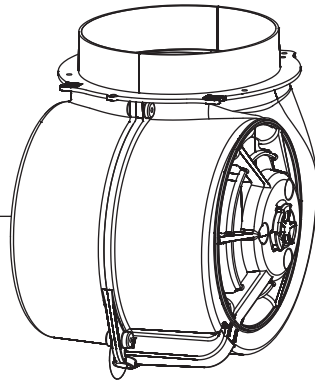

151



146

