

190

106

104

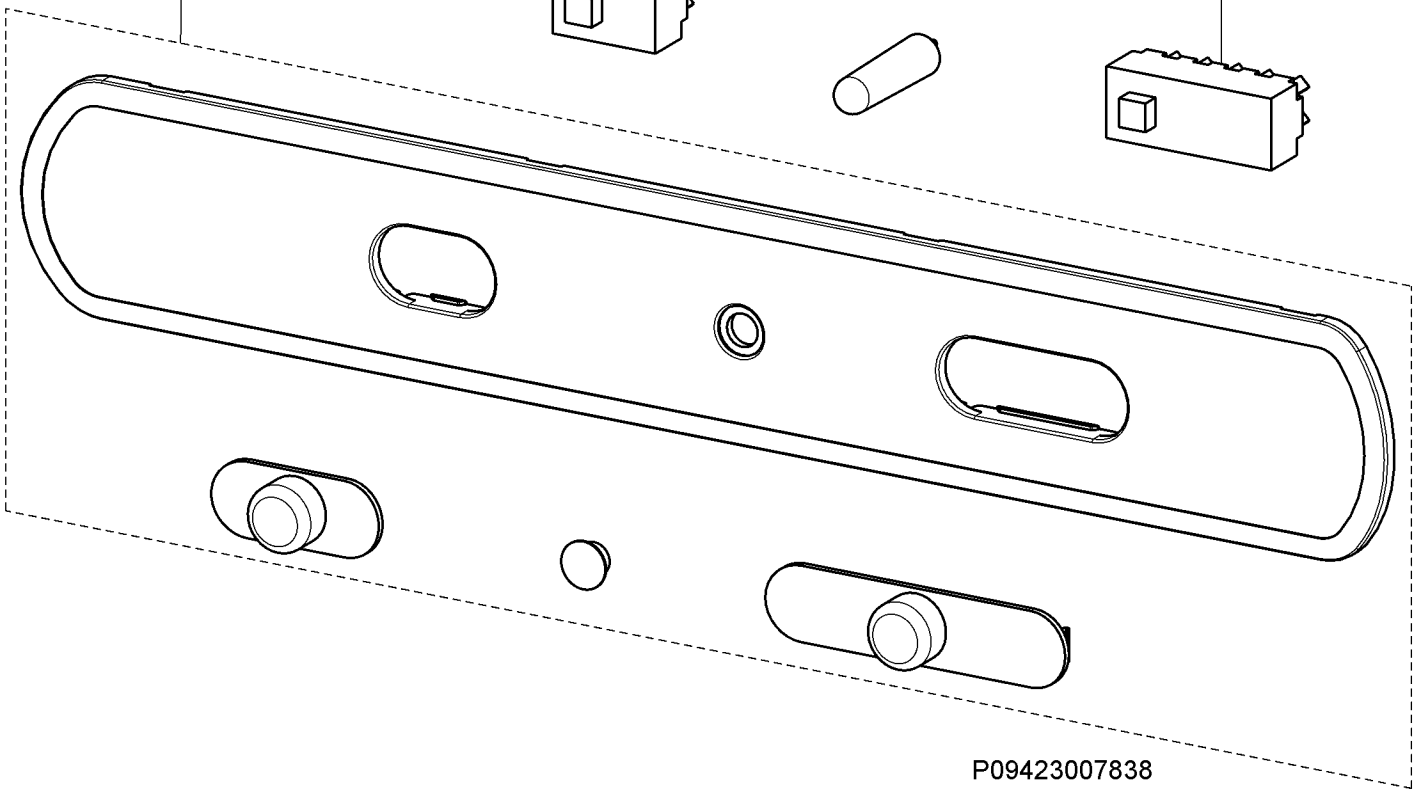
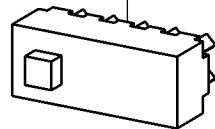
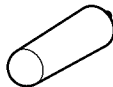
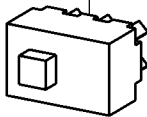

P09423007838