

103

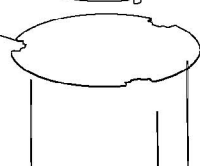

157



24

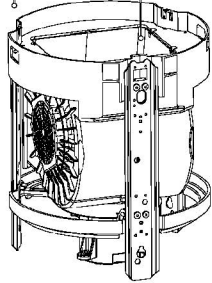

138

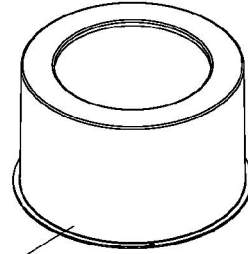

188

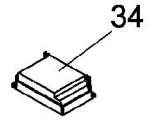

34

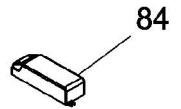

84

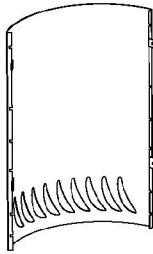

563

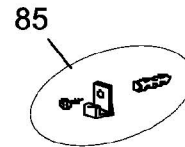
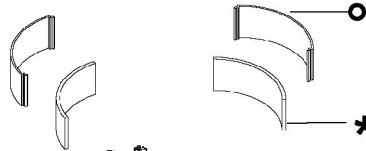

85



19

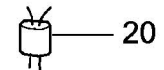

20

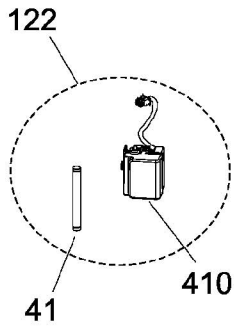

410

122

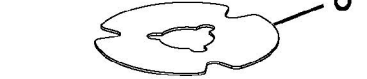
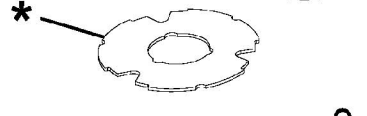
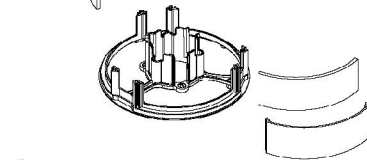

422

161

36



33

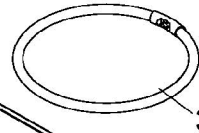

31



105

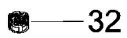

32

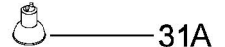

31A

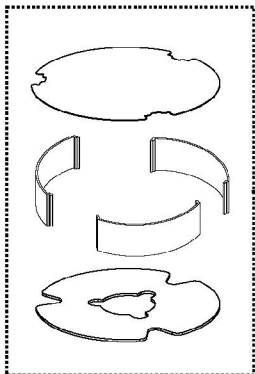

23

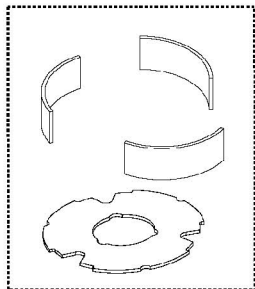

120

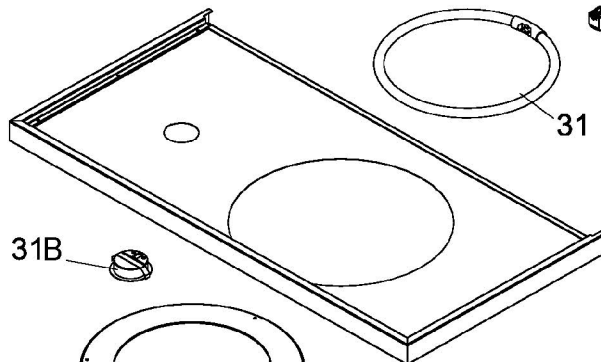

31B

38

P09423007410
(\$2044)