

57

56

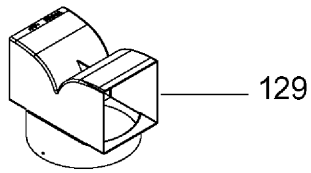

129

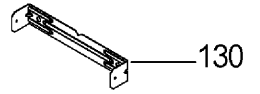

130

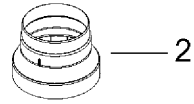

2

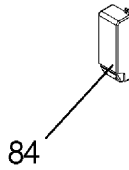

84

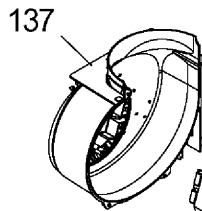
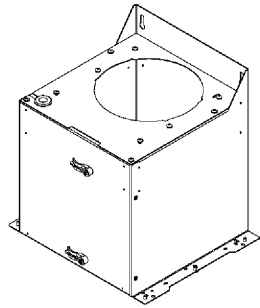

137



7

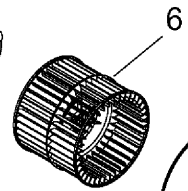

6

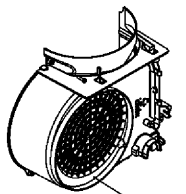

136

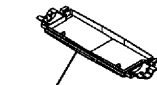
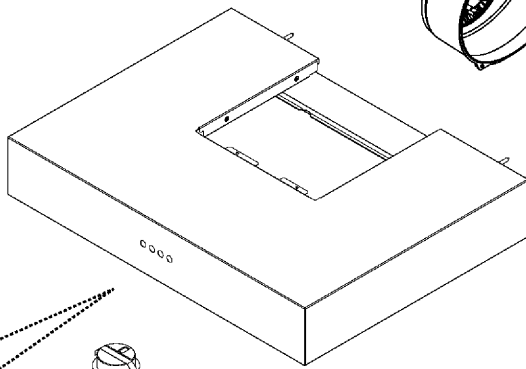

348

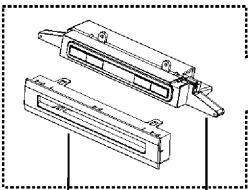

66

122



31

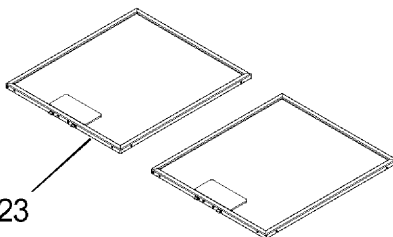

23

22