

240

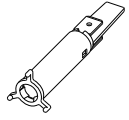

242

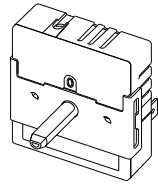

222D

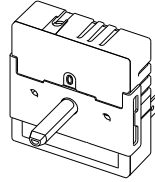

222S

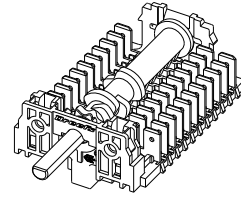

226

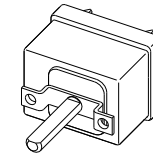

230

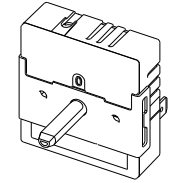

222S

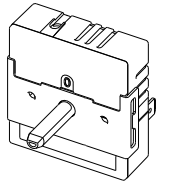

222D

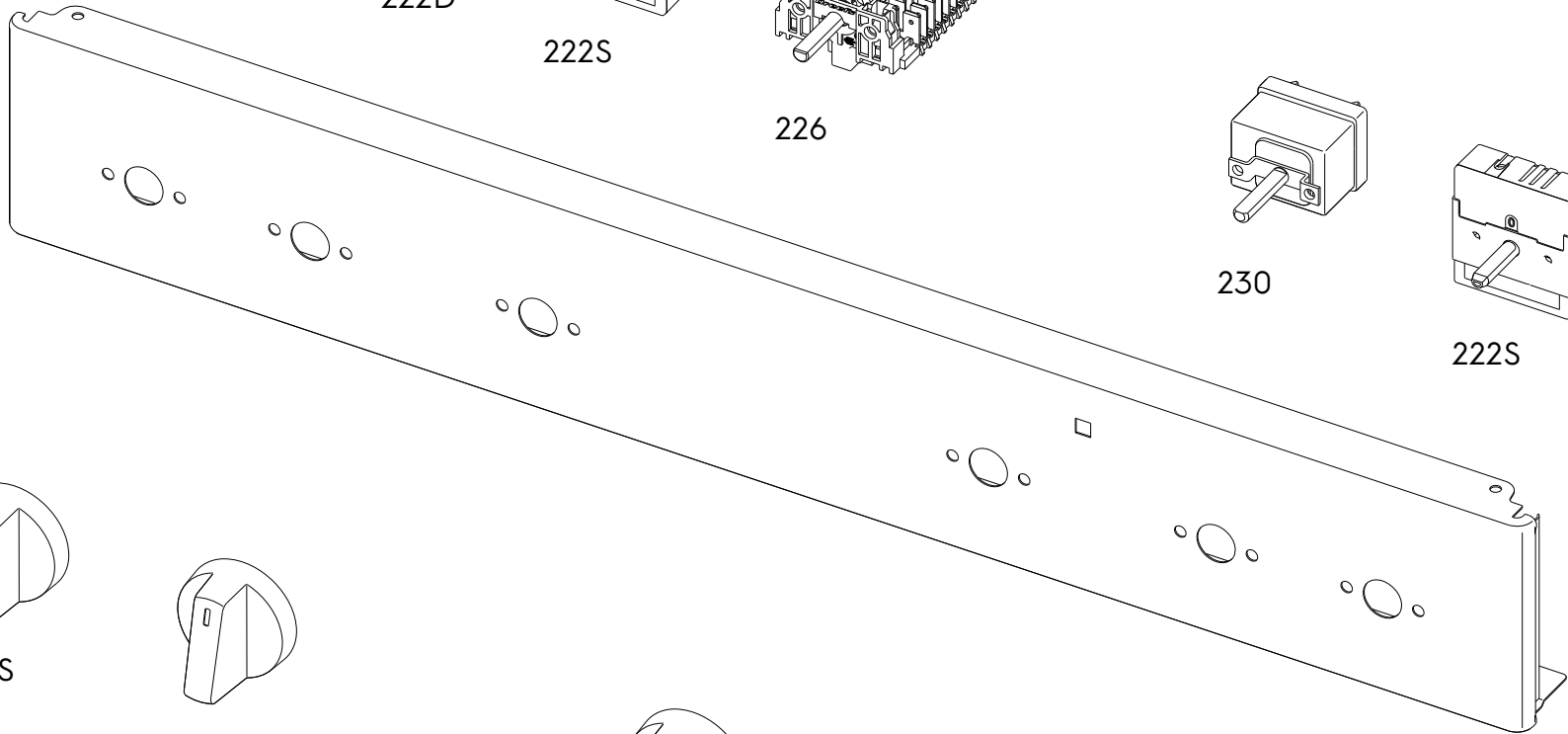

210



200D

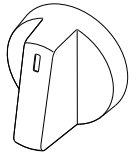

200S

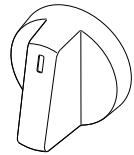

200F

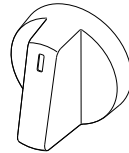

200T



200S

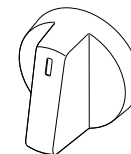

200D