

242

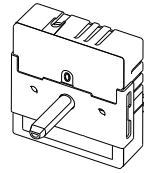

222

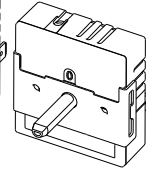

222

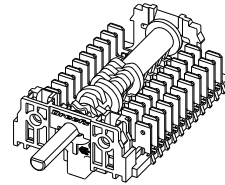

226

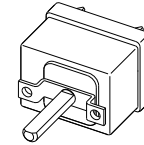

230

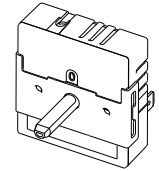

222

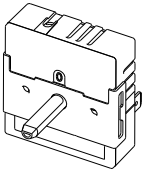

222

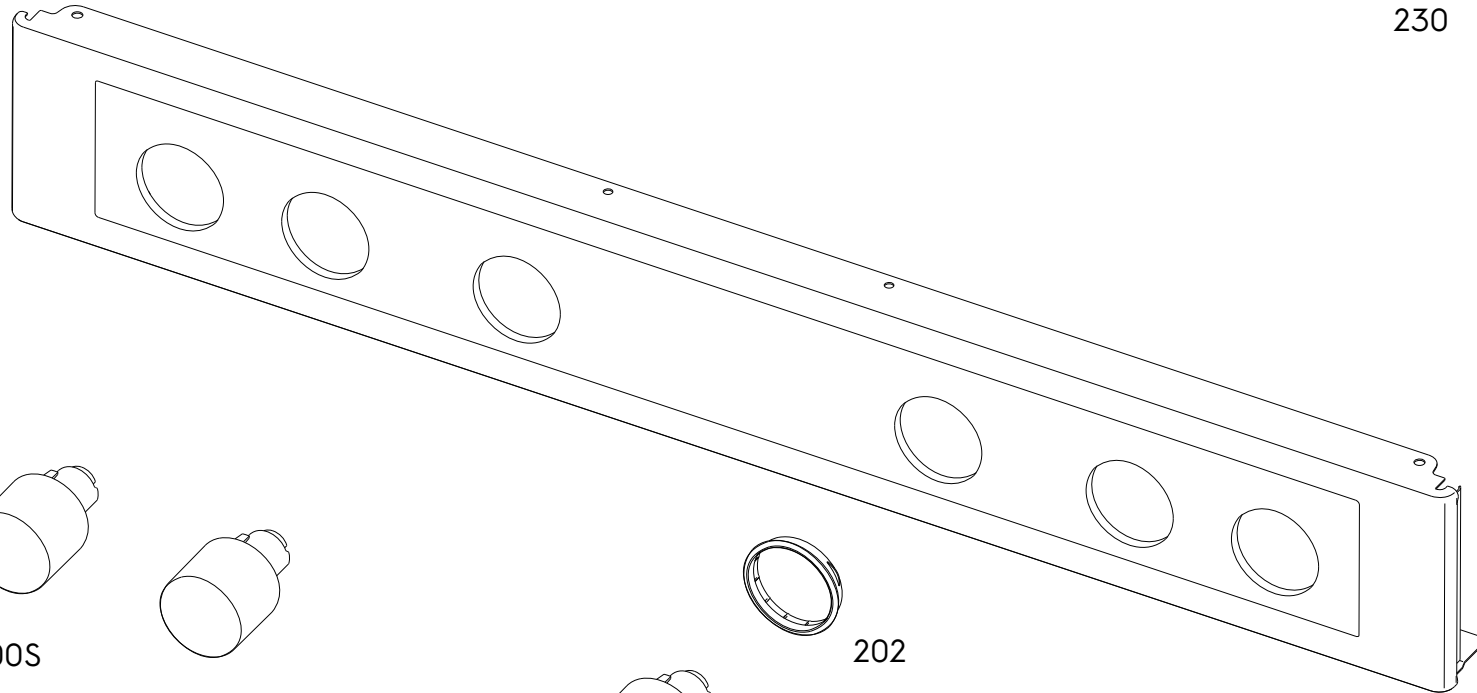

210

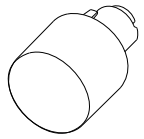

200S

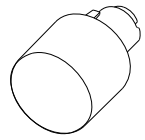

200S

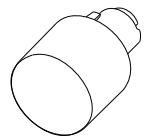

200F



202

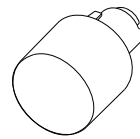

200T

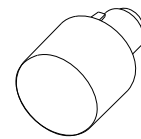

200S

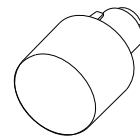

200S