

242

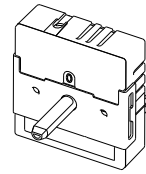

222S

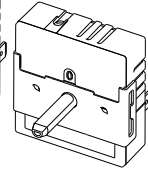

222S

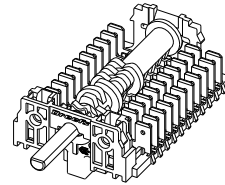

226

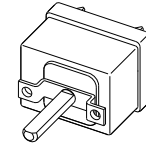

230

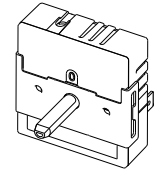

222S

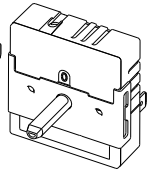

222S

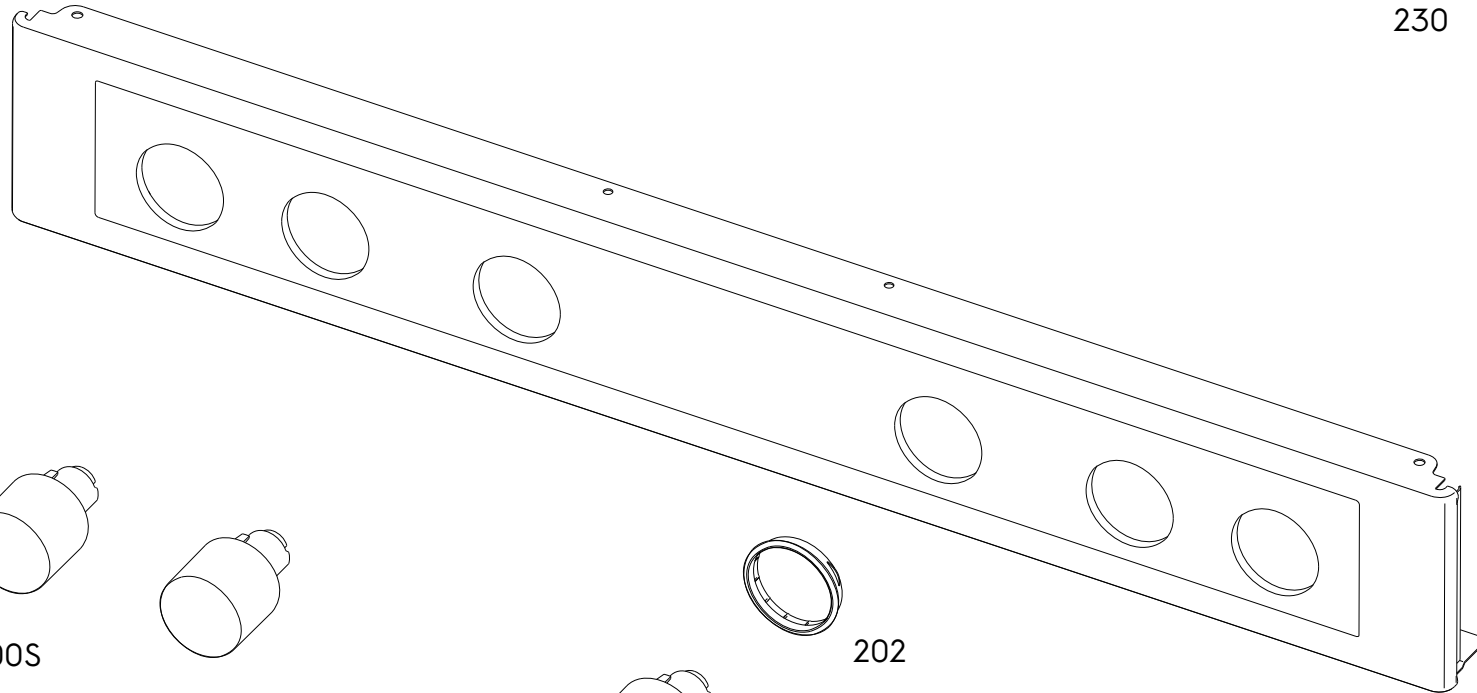

210

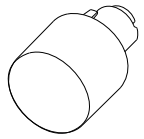

200S

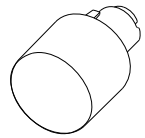

200S

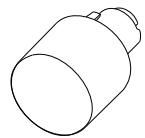

200F



202

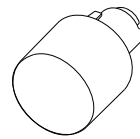

200T

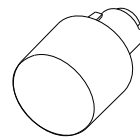

200S

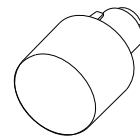

200S