

240

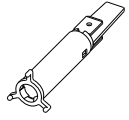

242

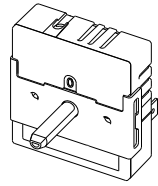

222D

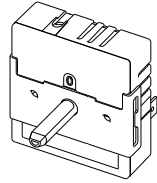

222S

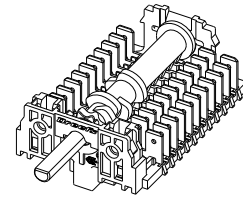

226

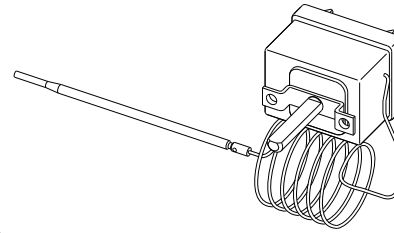

230

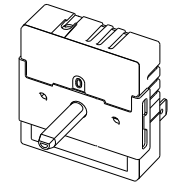

222D

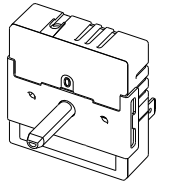

222D

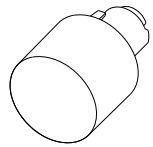

200D

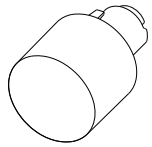

200S

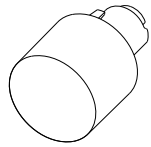

200F

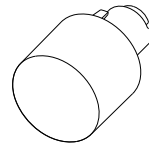

200T

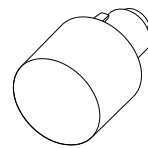

200D

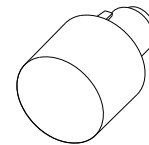

200D

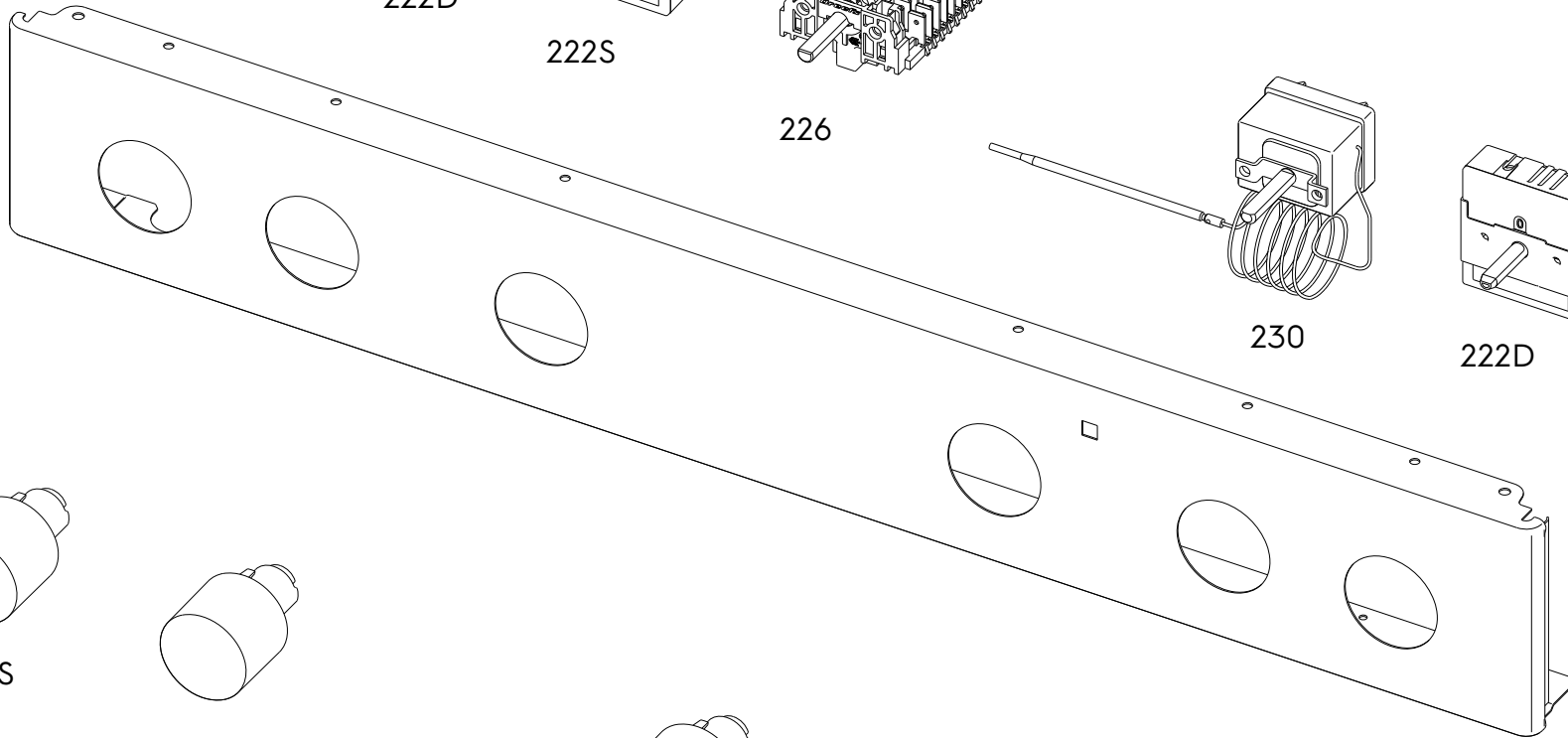

210

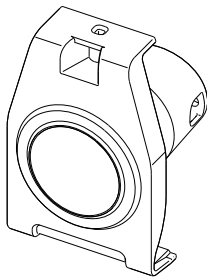

208