

242

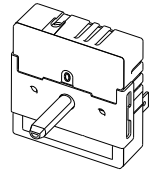

222D

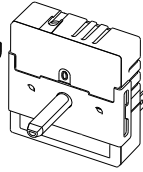

222S

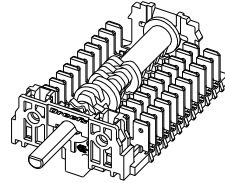

226

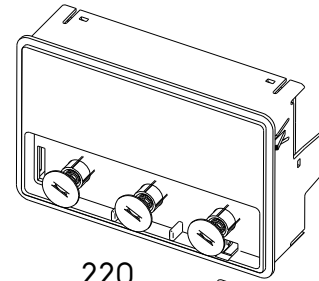

220

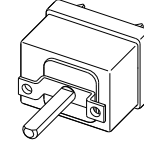

230

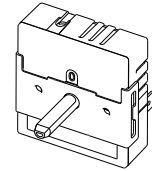

222S

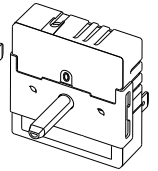

222D

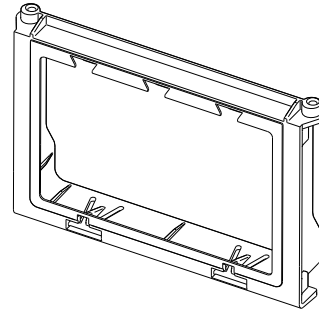

224

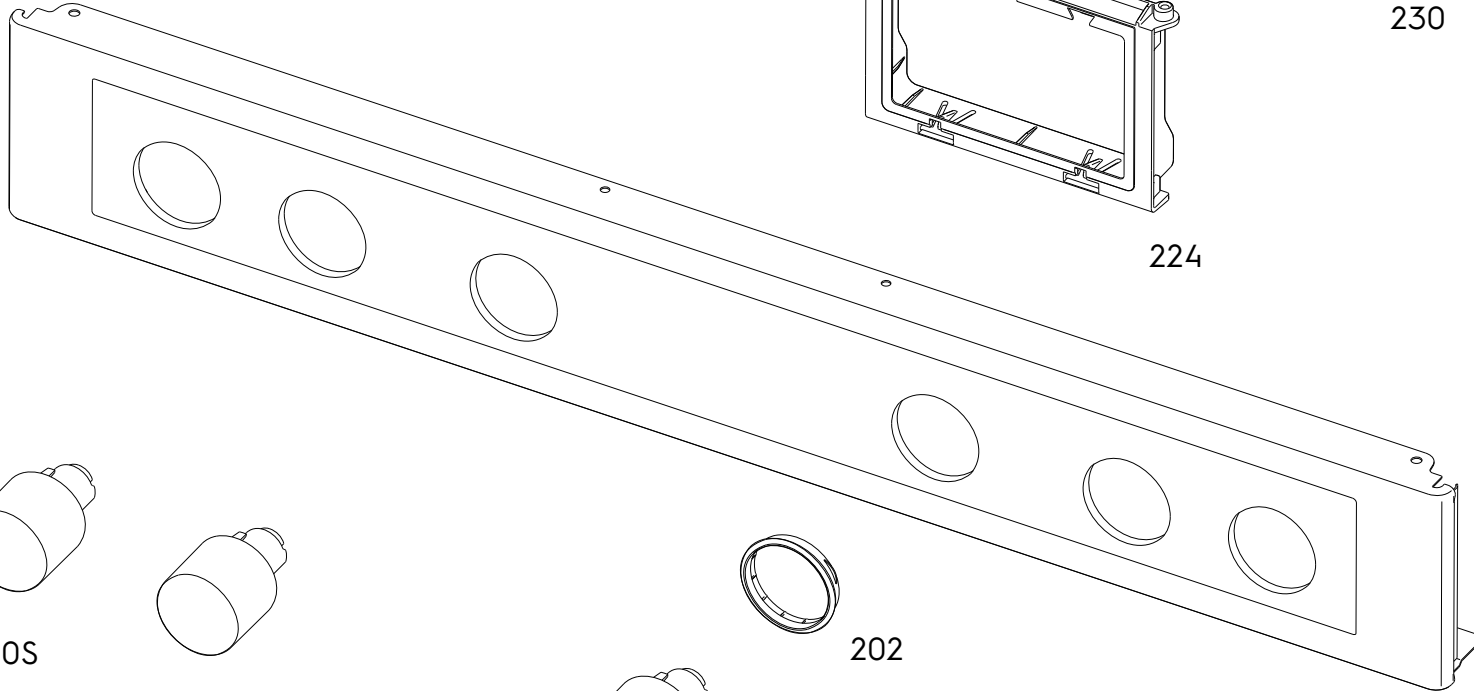

210

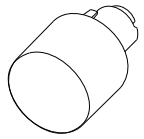

200D

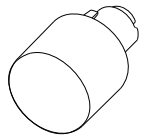

200S

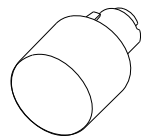

200F



202

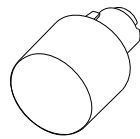

200T

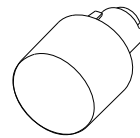

200S

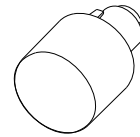

200D