

242

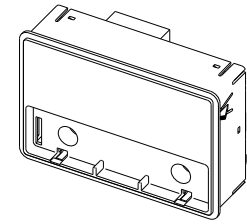

220



229



228

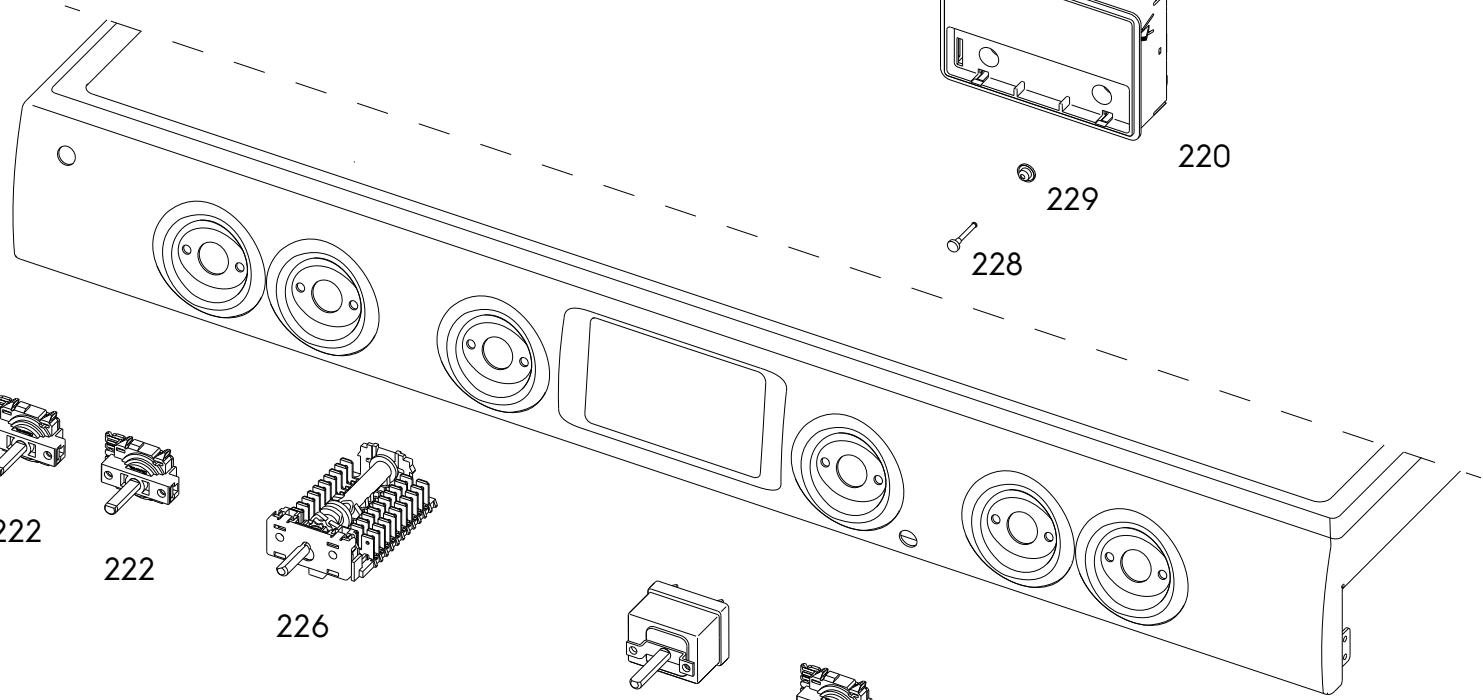

222



222

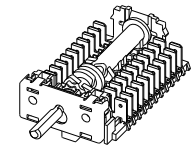

226

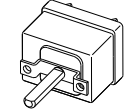

230

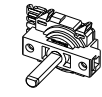

222

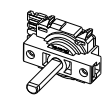

222



290



290



290A



200S



200S

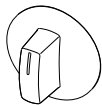

200F

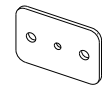

290

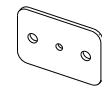

290

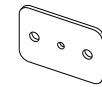

290



200T



200S

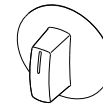

200S