

240

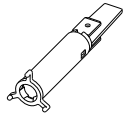

242

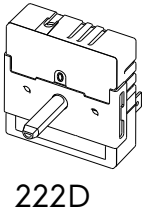

222D

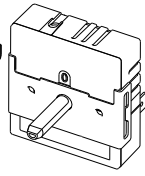

222S

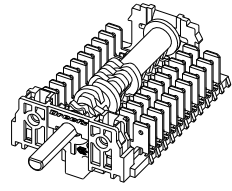

226

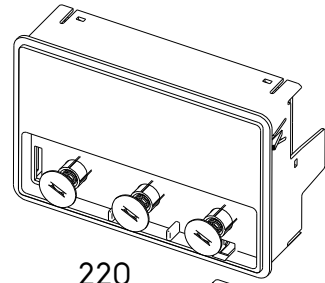

220

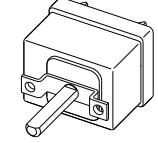

230

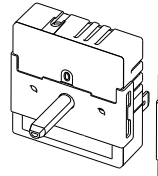

222D

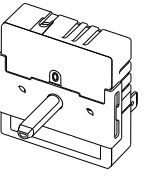

222D

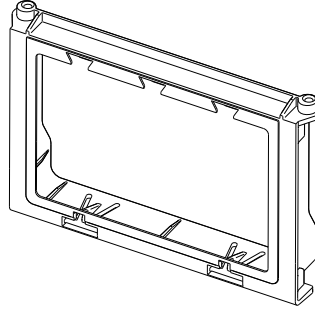

224

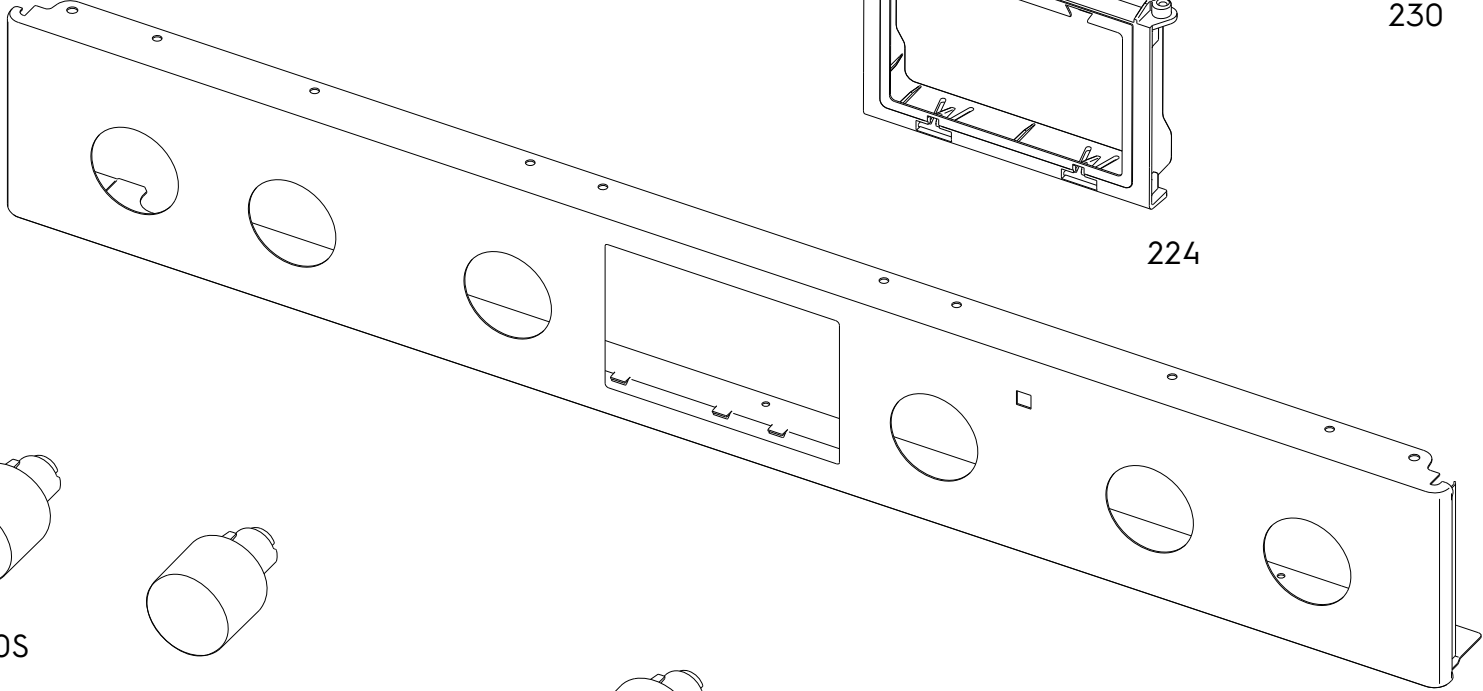

210

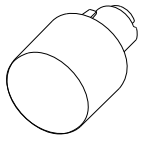

200D

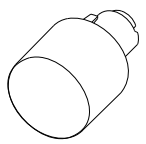

200S

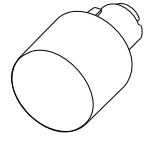

200F

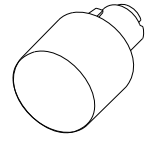

200T

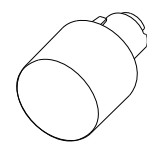

200D

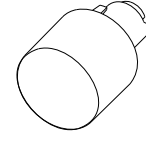

200D

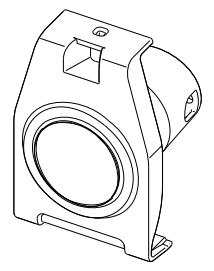

208