

240

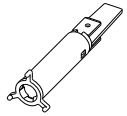

242

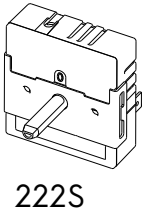

222S

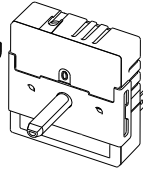

222S

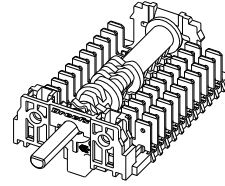

226

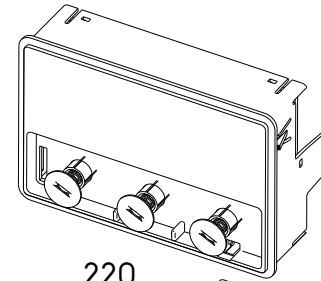

220

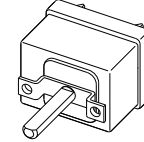

230

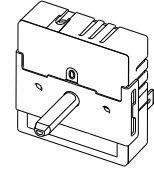

222S

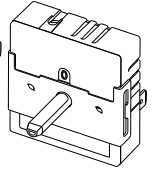

222S

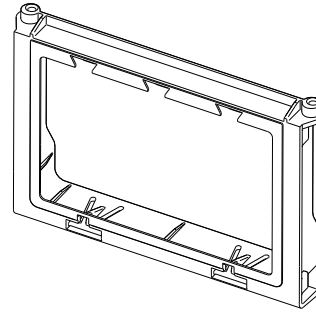

224

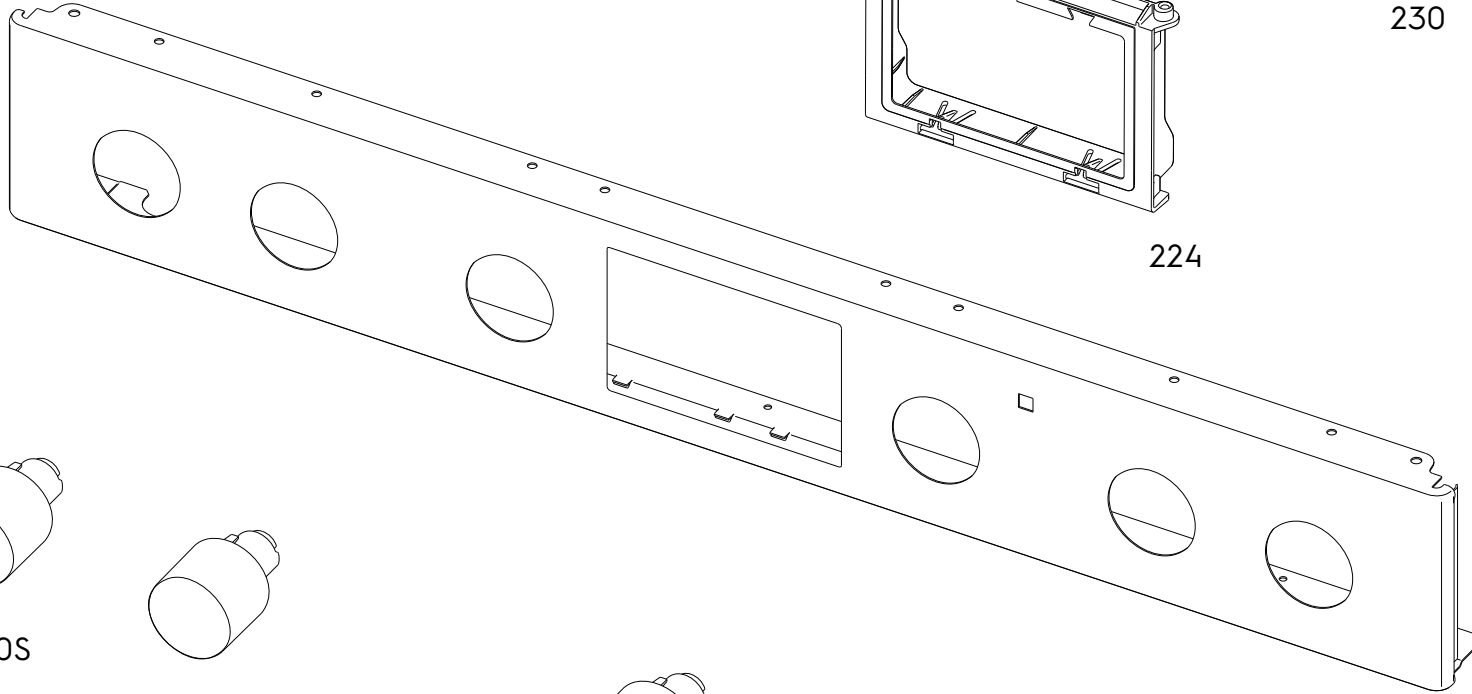

210

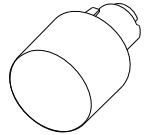

200S

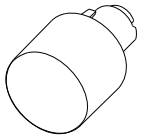

200S

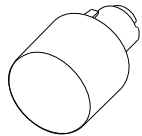

200F

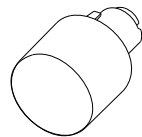

200T

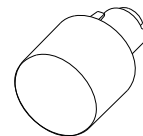

200S

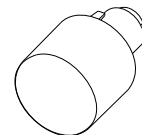

200S

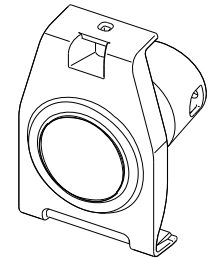

208