

242

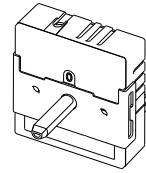

222D

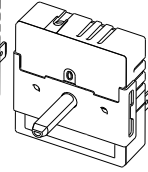

222S

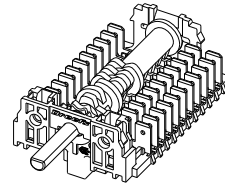

226

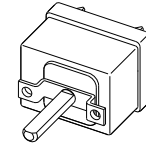

230

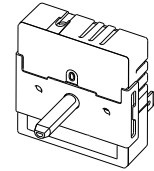

222D

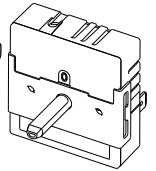

222S

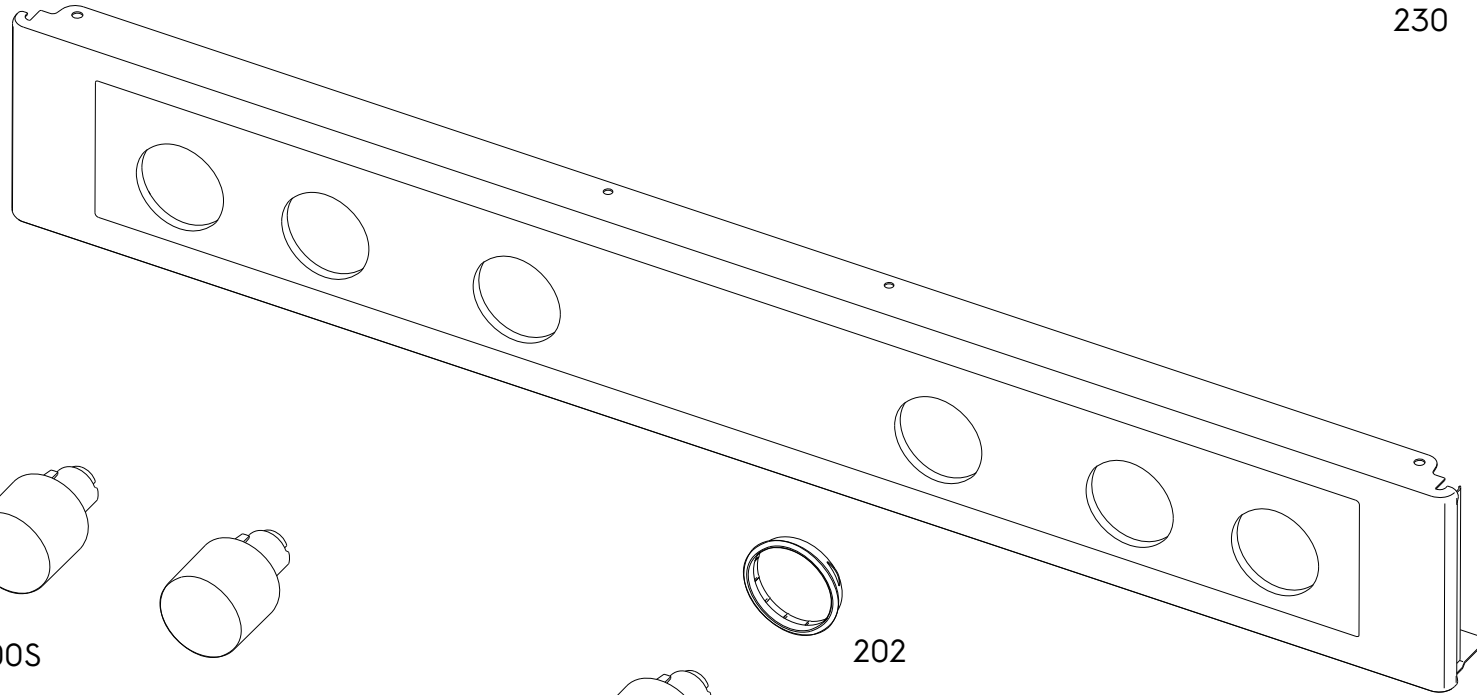

210

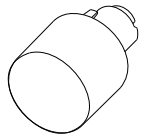

200D

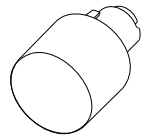

200S

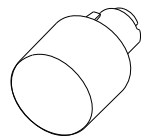

200F



202

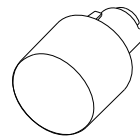

200T

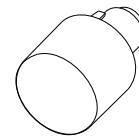

200D

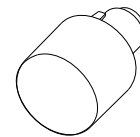

200S