

240

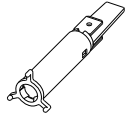

242

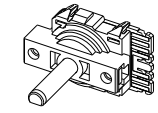

222

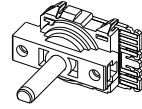

222

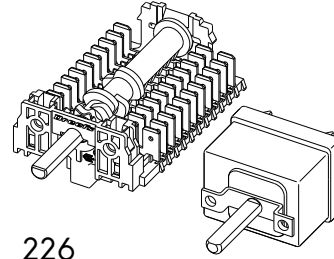

226

230

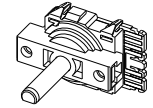

222

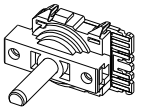

222

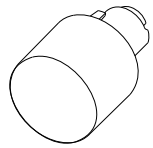

200S

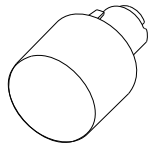

200S

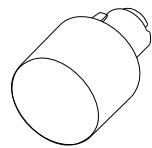

200F

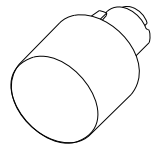

200T

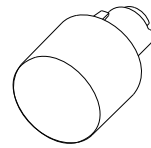

200S

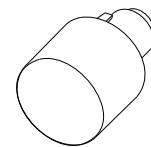

200S

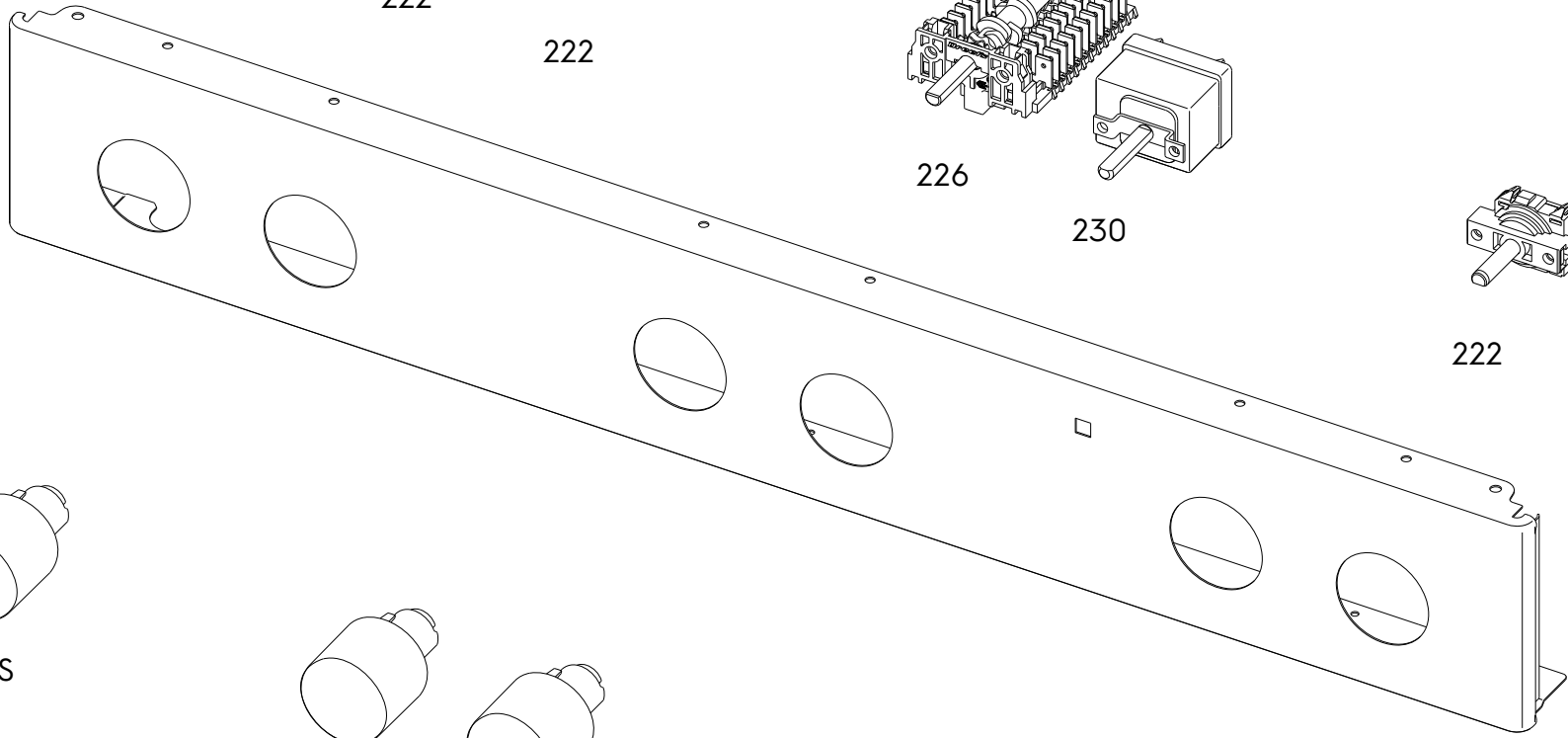

210

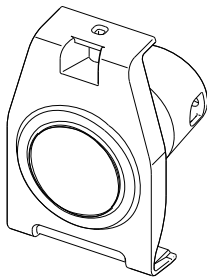

208