

240

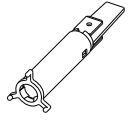

242

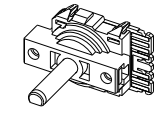

222

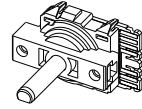

222

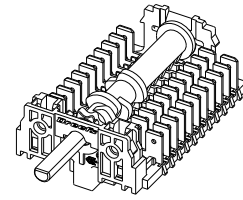

226

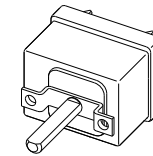

230

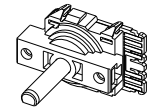

222

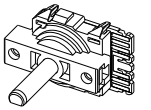

222

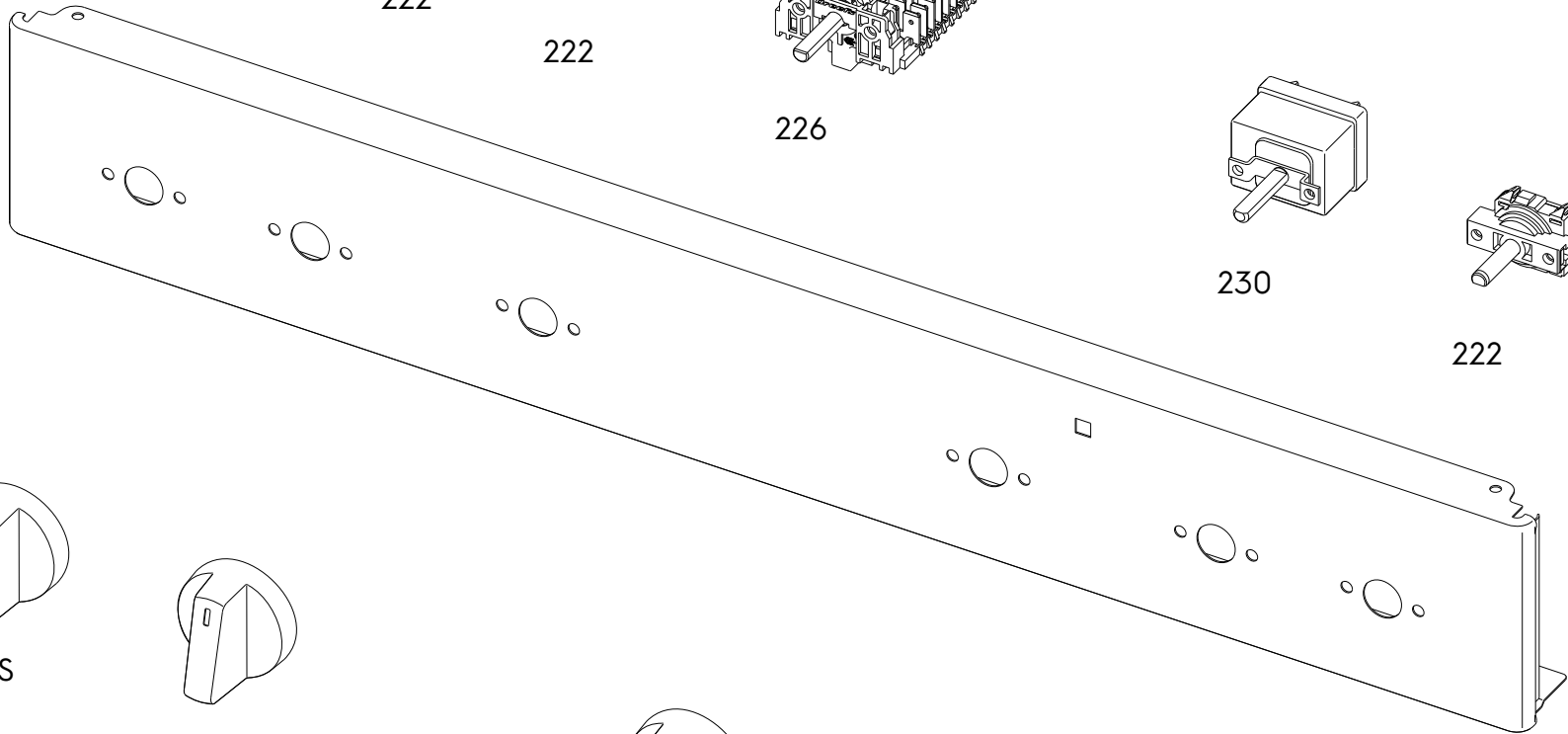

210

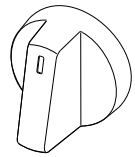

200S

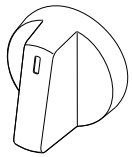

200S

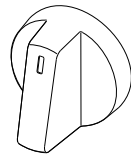

200F

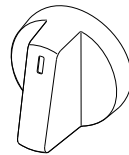

200T



200S



200S