

242

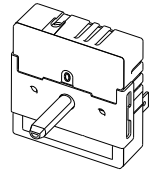

222D

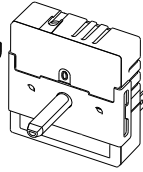

222S

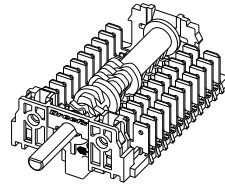

226

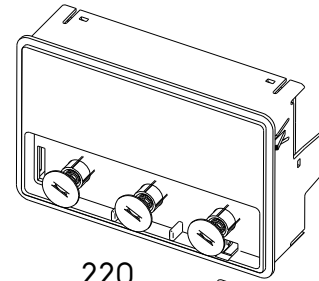

220

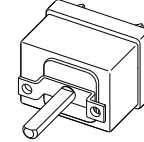

230

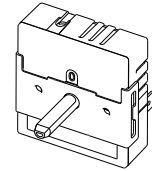

222D

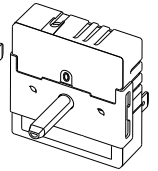

222S

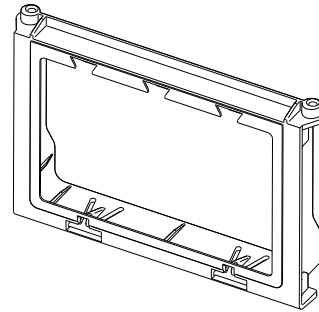

224

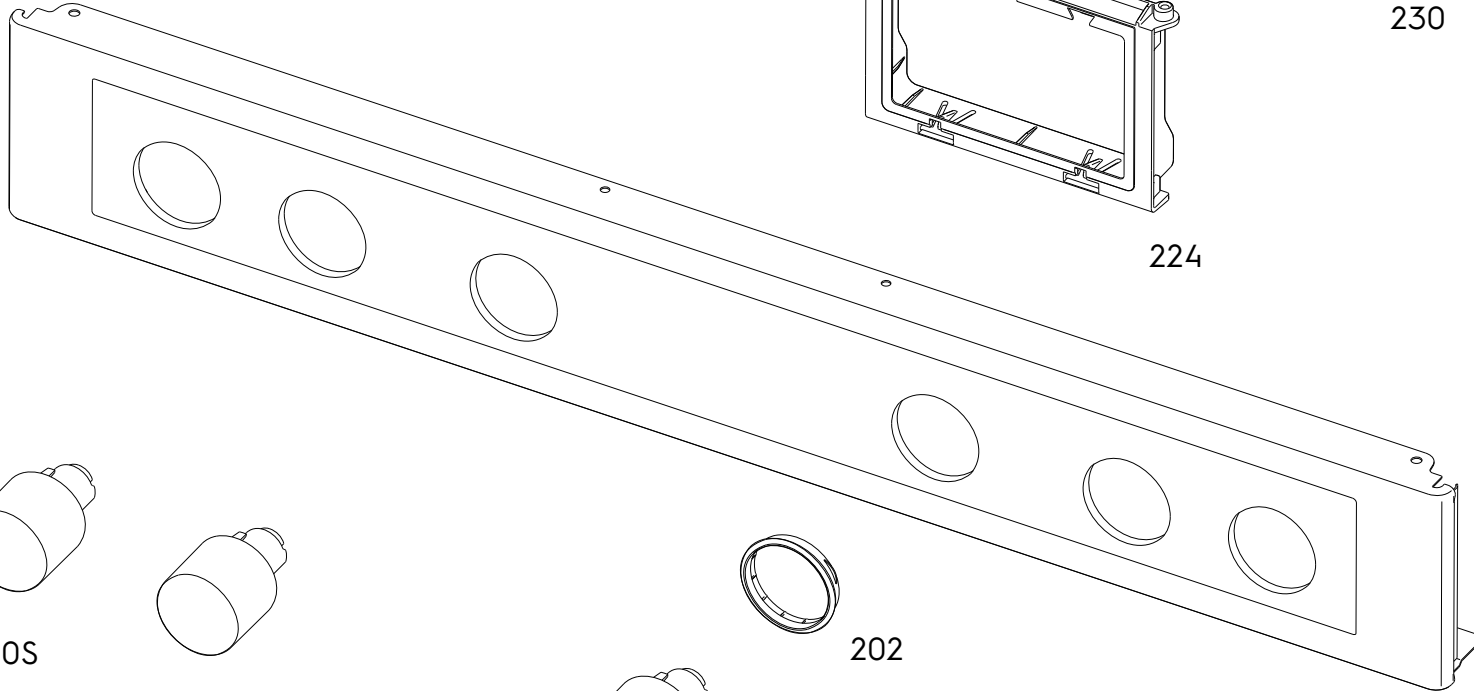

210

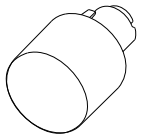

200D

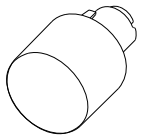

200S

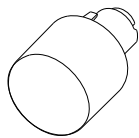

200F



202

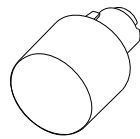

200T

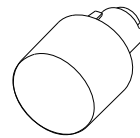

200D

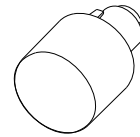

200S