

240

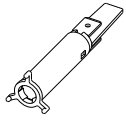

242

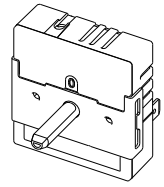

222S

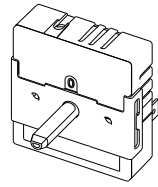

222S

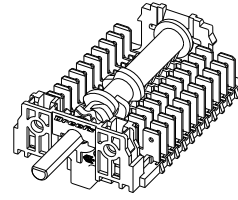

226

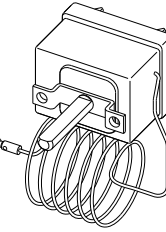

230

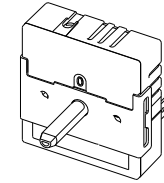

222S

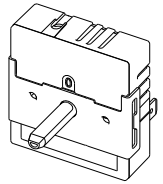

222S

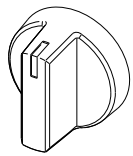

200S

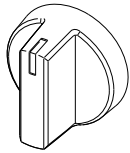

200S

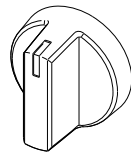

200F

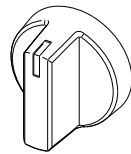

200T

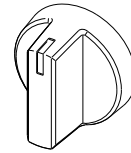

200S

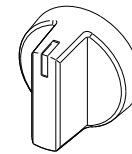

200S

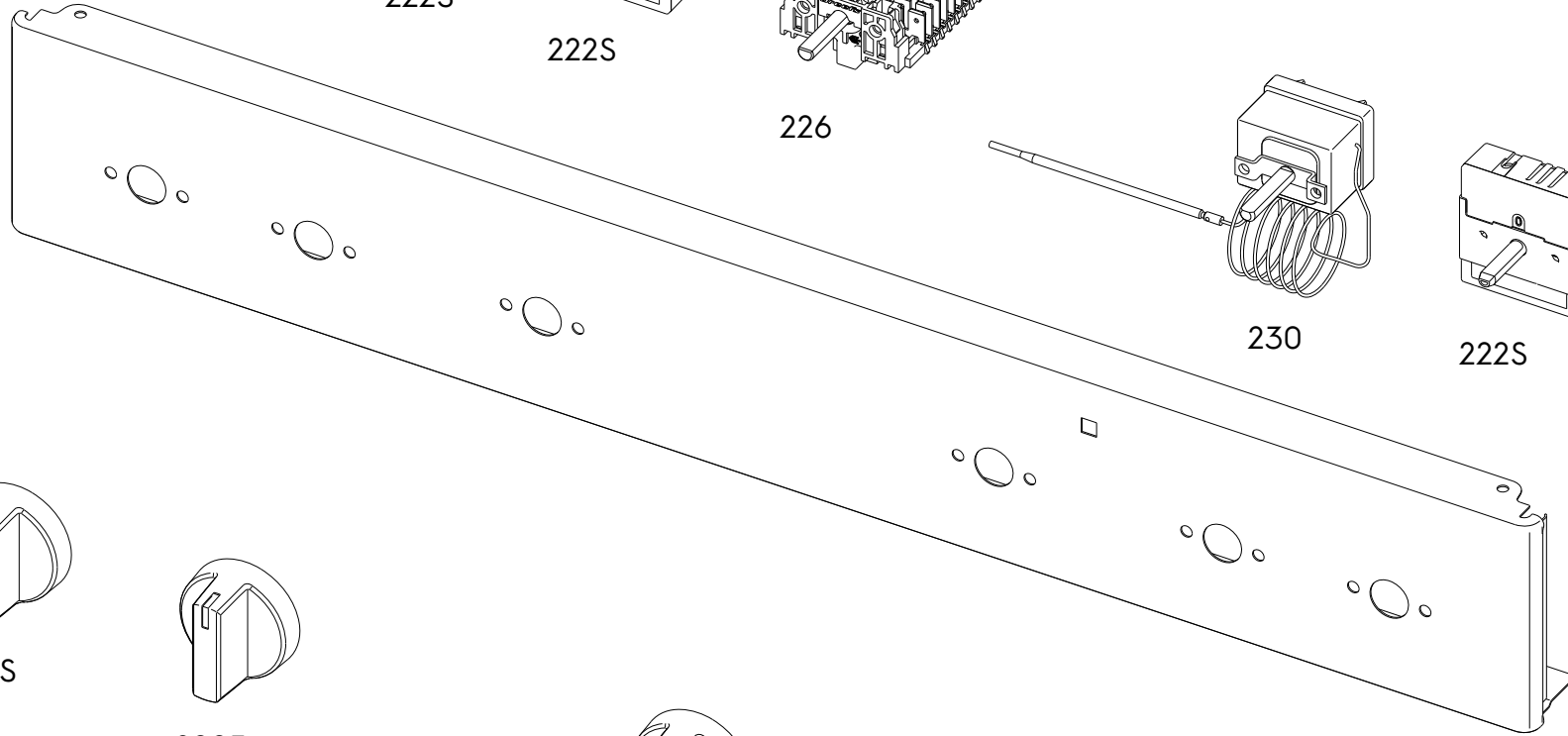

210