



522



522B



530

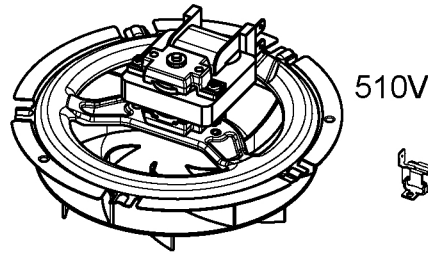

510V



518V

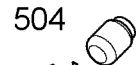

504

506U



502U

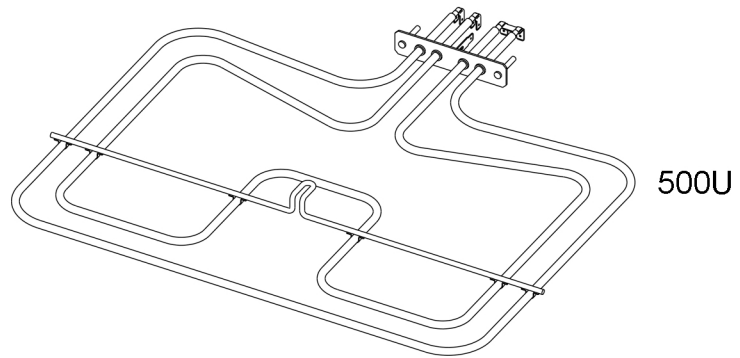

500U

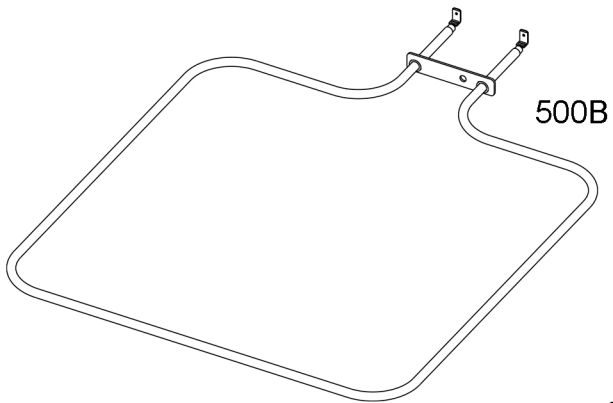

500B

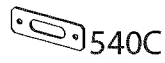

540C

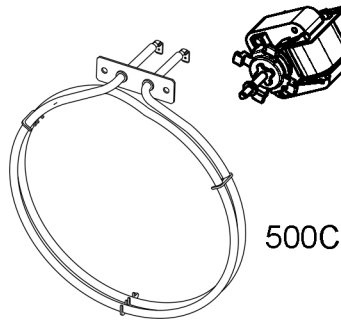

500C



510C



522A

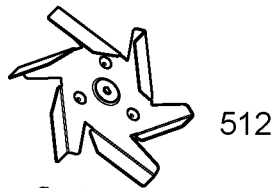

512



513