

111

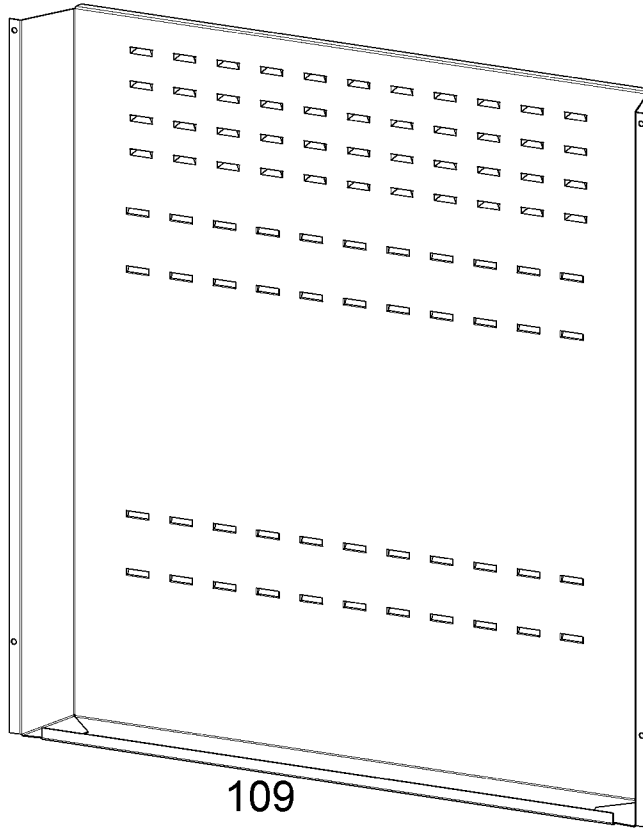

109

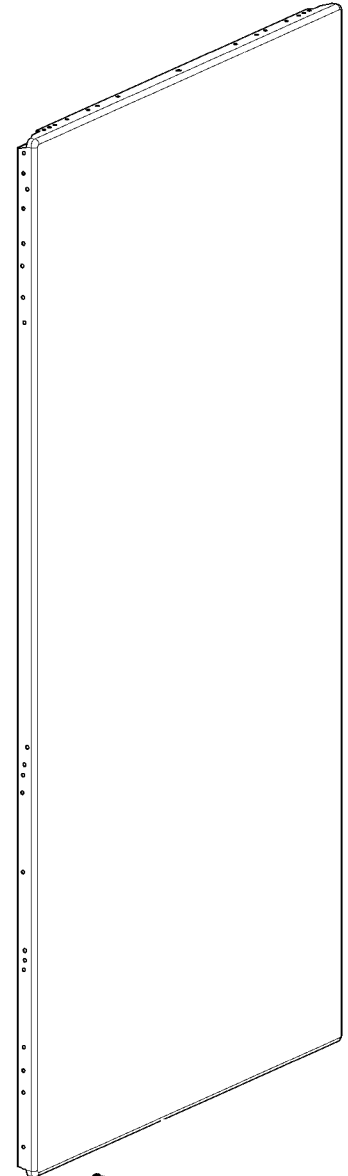

111

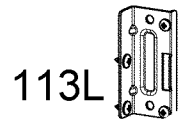

113L

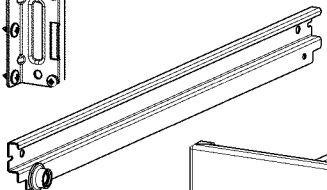

124L

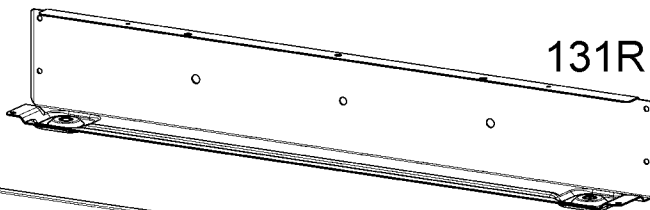

131R

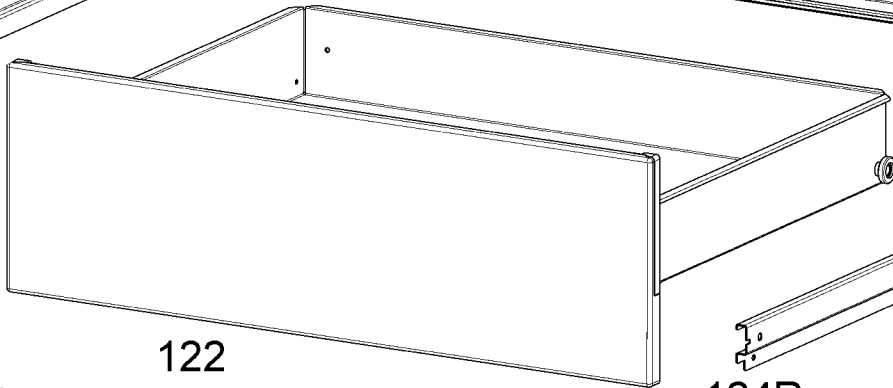

122

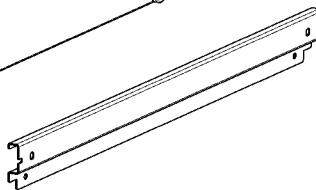

124R

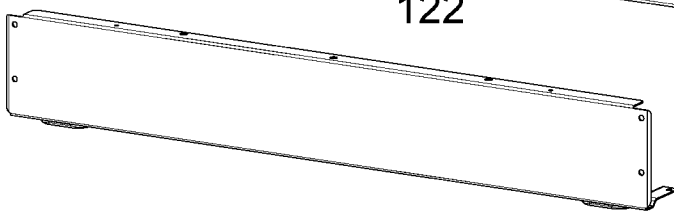

131F

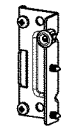

113R



115