

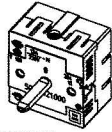

222D

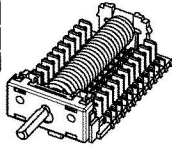

222S



226

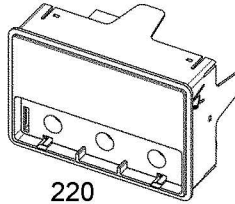

220

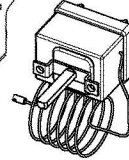

230

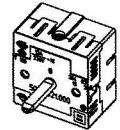

222D

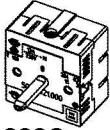

222S

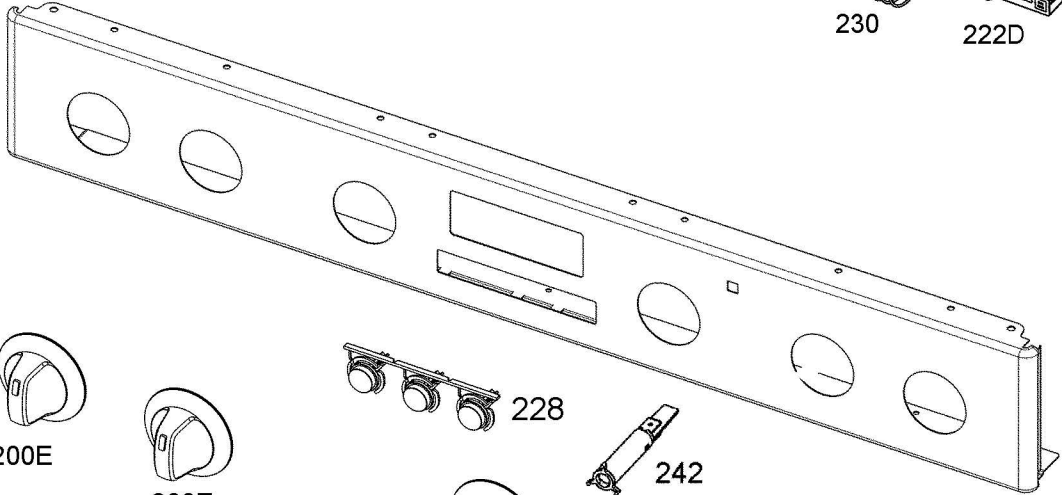

210



200D



200E



200F



228



242



200T



200D



200E