

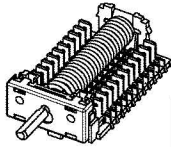

242

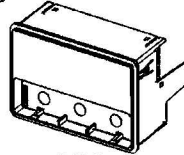

226



220

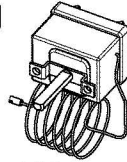

230

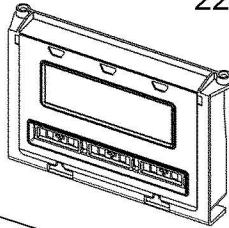

224

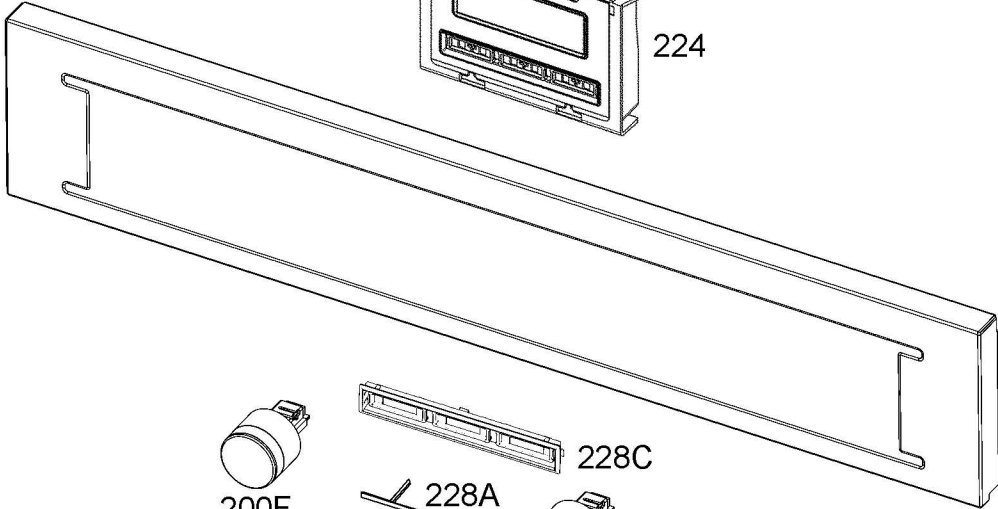

210



200F

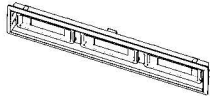

228C

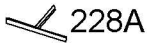

228A



228



200T



202