

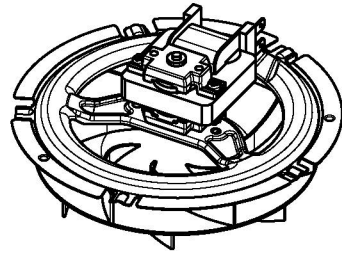

522



510V



518V

513A

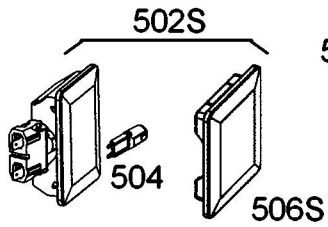

502S

504

506S

502U



504



506U

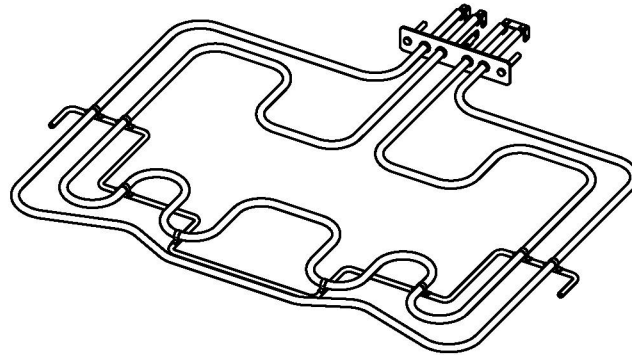

500U



522A



539



522C

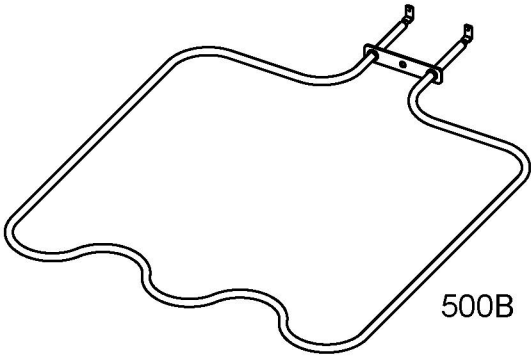

500B

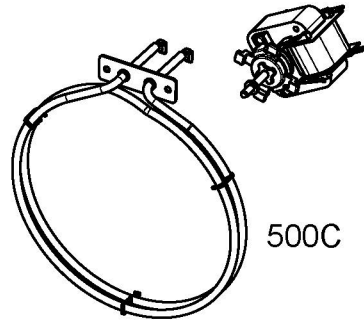

500C

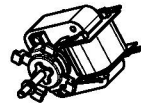

510C

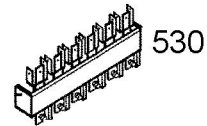

530

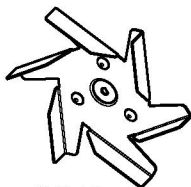

512

513

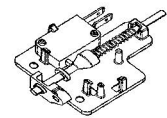

520