

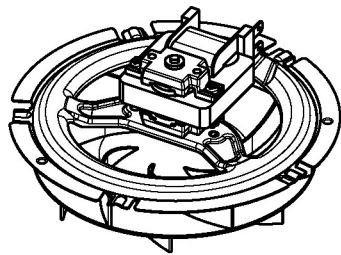

522



510V



518V



502U



504U



506U

513A

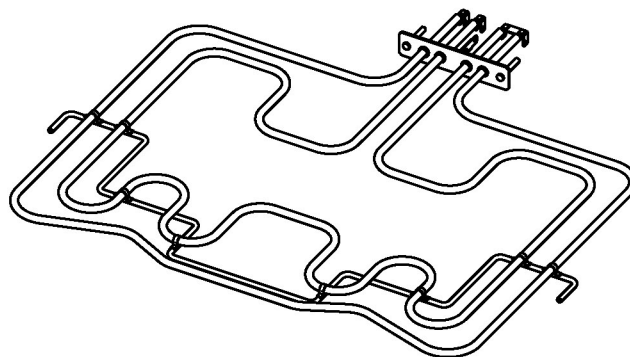

500U

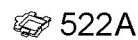

522C

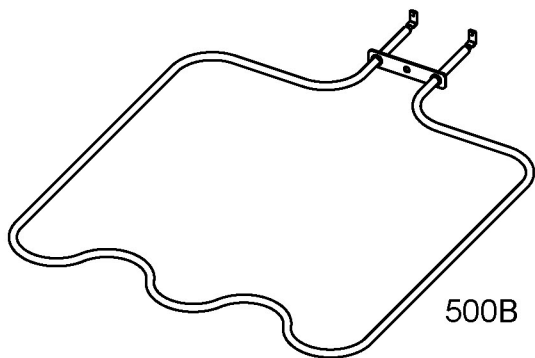

500B

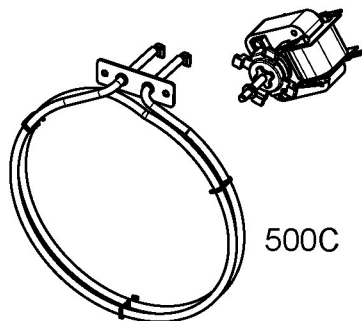

510C

500C

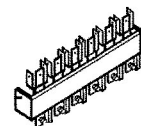

530

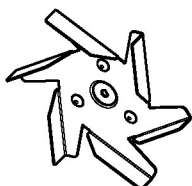

512

513