

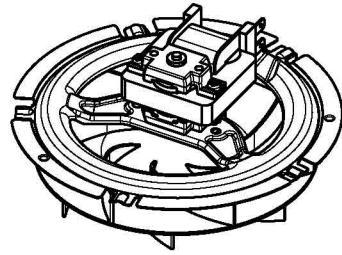

522



510V



518V

513A



522A



502U



504



506U

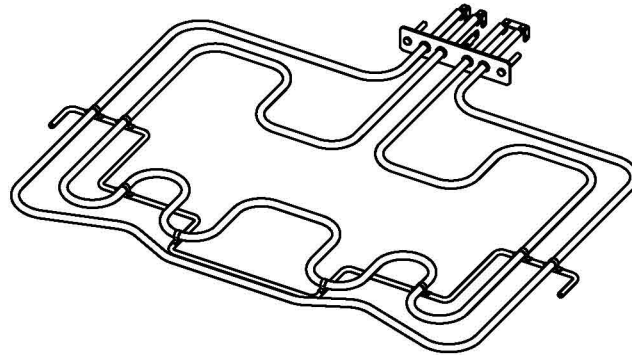

500U



522C

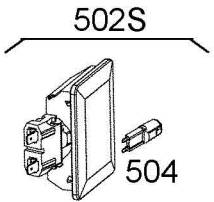

502S

504

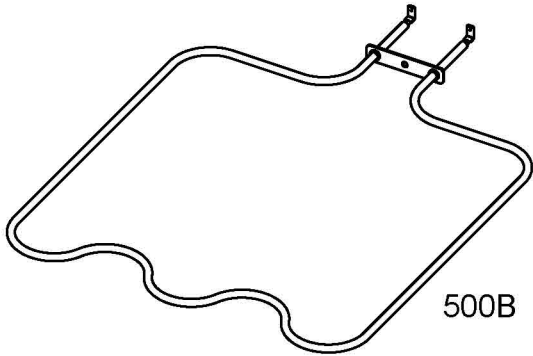

500B

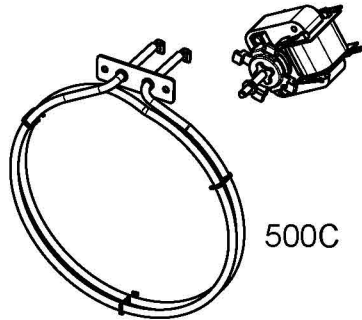

500C

510C

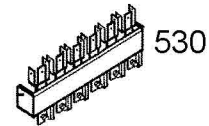

530

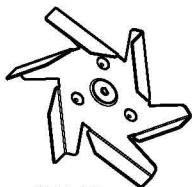

512

513

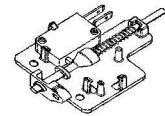

520