

111

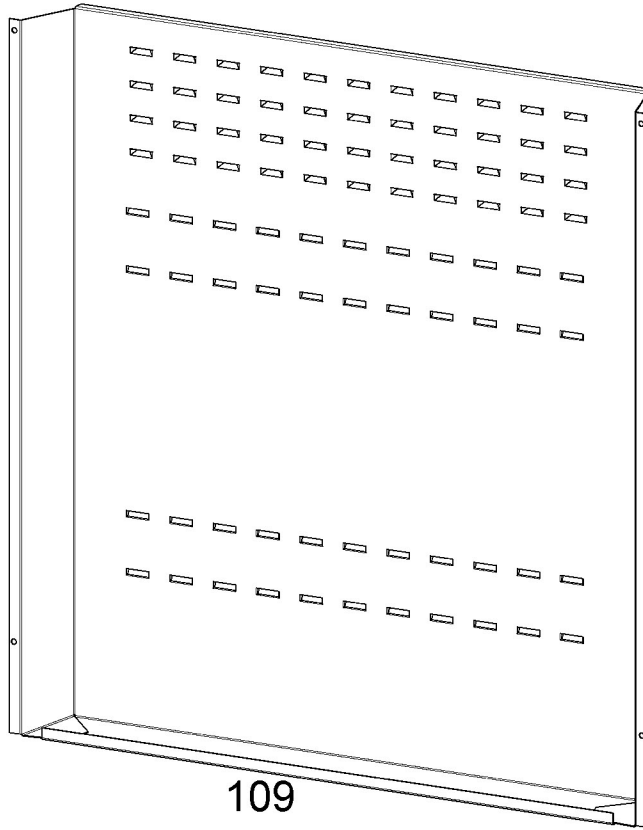

109

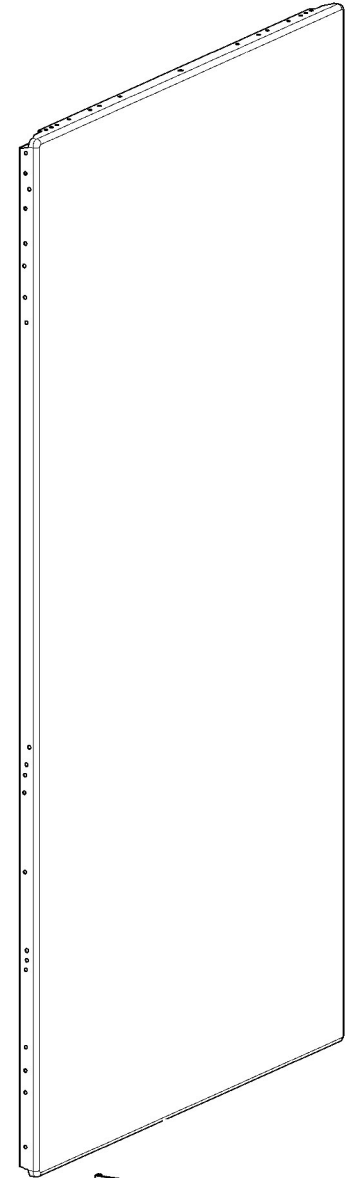

111

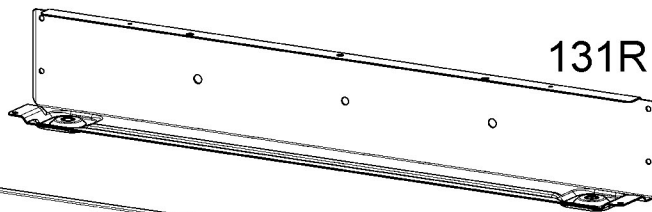

131R

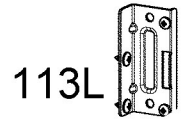

113L

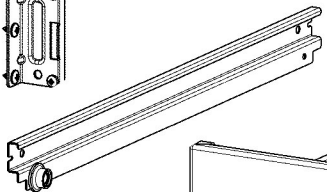

124L

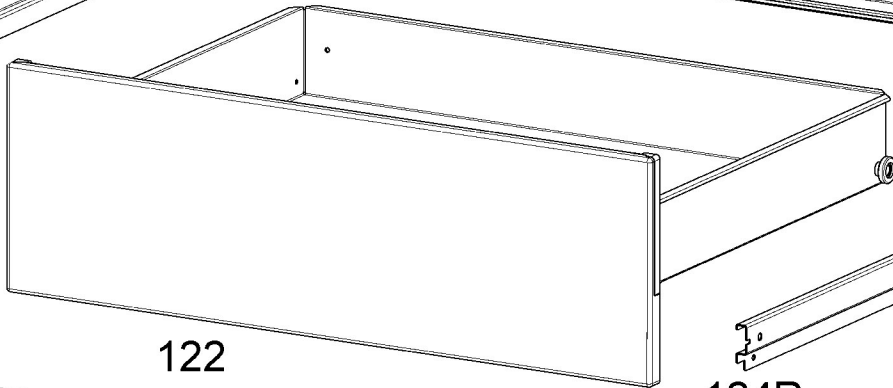

122

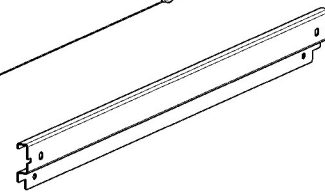

124R



123

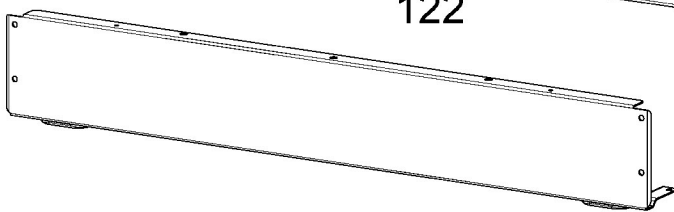

131F



115

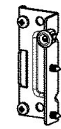

113R