

112L

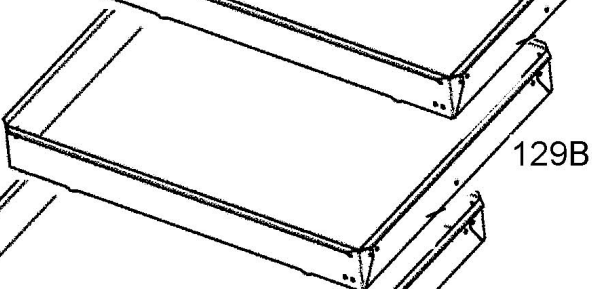

128

112R

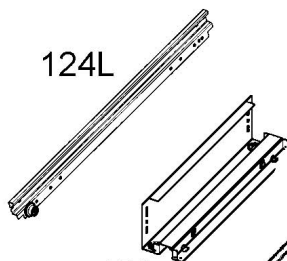
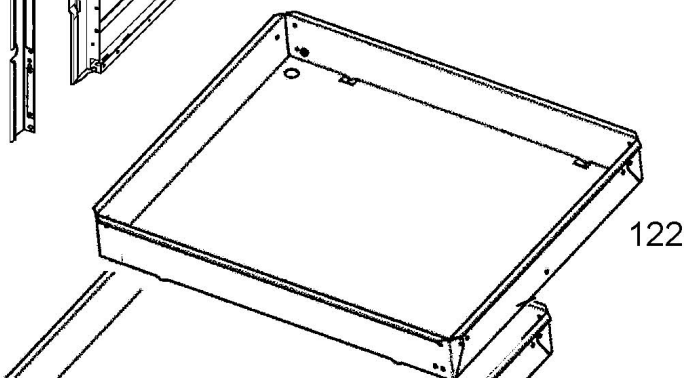
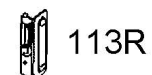
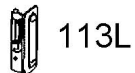
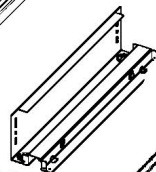

129A

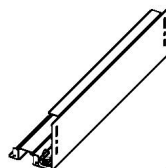

124R

