

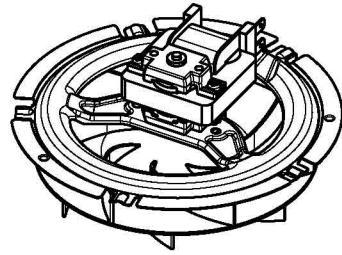

522



510V



518V

513A

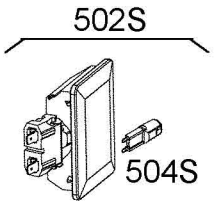

502S

504S

502U



504U



506U

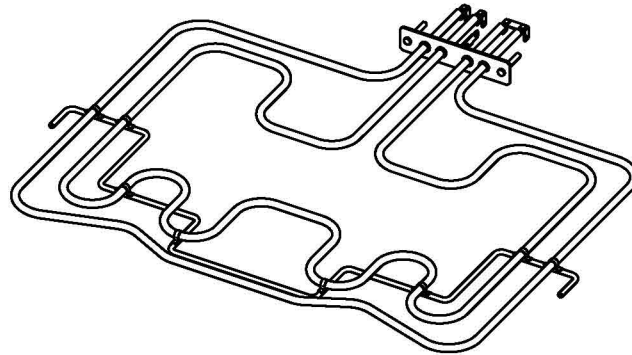

522A

500U



539



522C

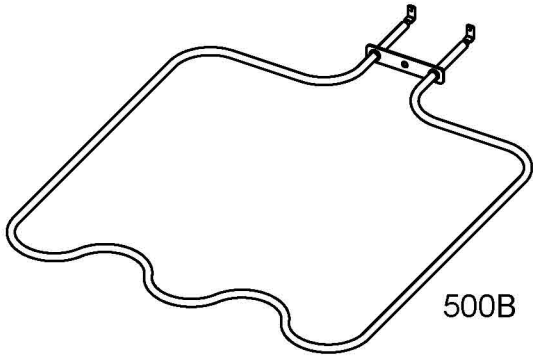

500B

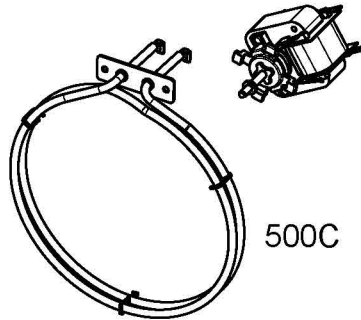

500C

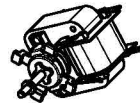

510C

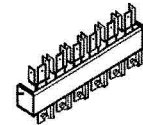

530

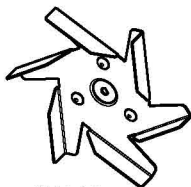

512

513

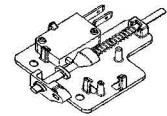

520