

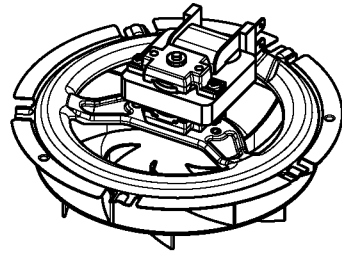

522



510V



518V

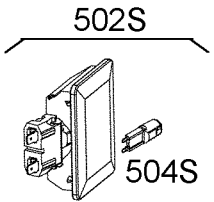

502S

504S

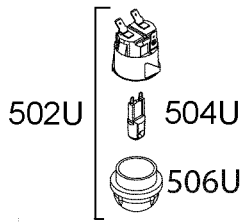

502U

504U

506U

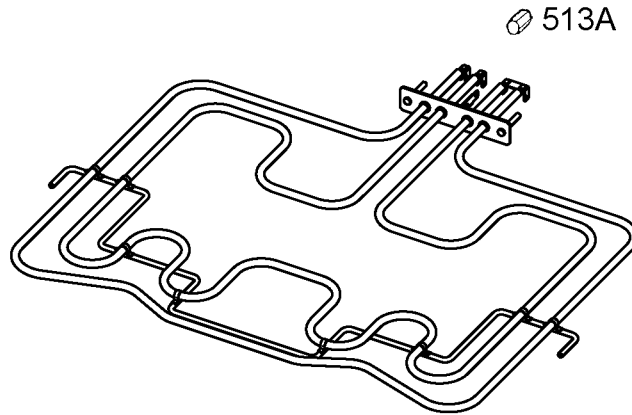

513A

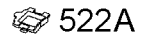

522A

500U



522C

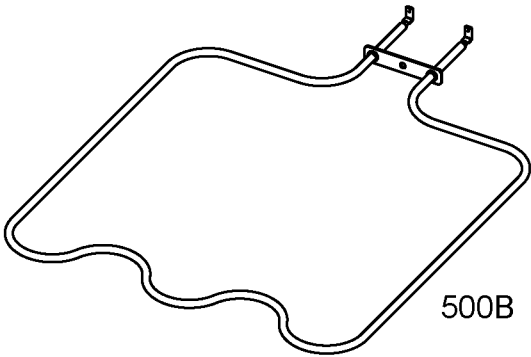

500B

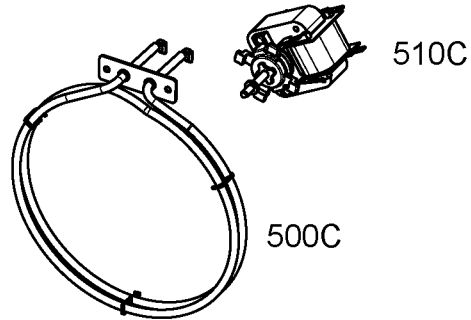

500C

510C

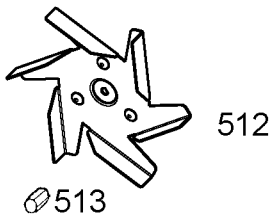

512

513