

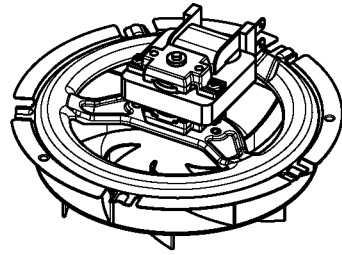

522



510V



518V

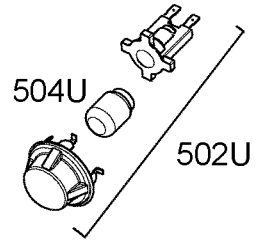

504U

502U

513A

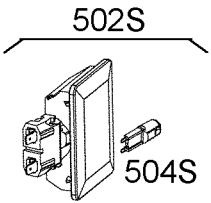

502S

504S

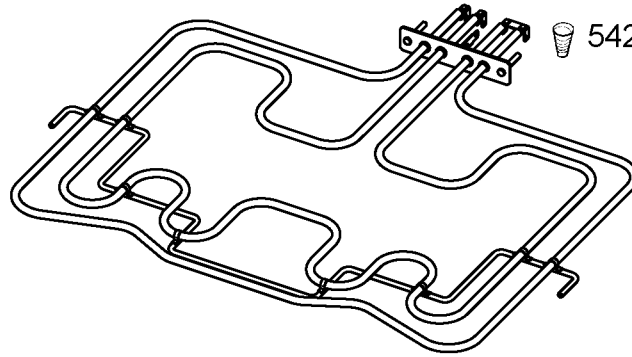

542G

500U



539



522C

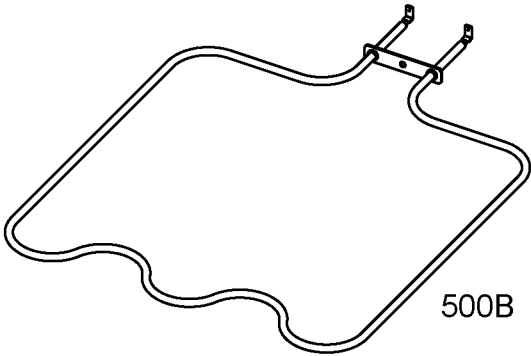

500B

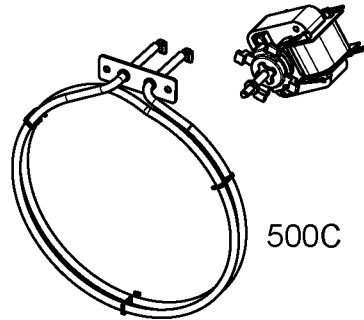

500C



510C

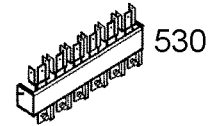

530

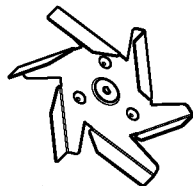

512

513