

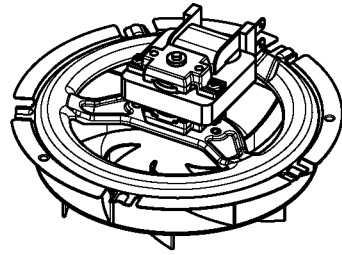

522



510V



518V

513A

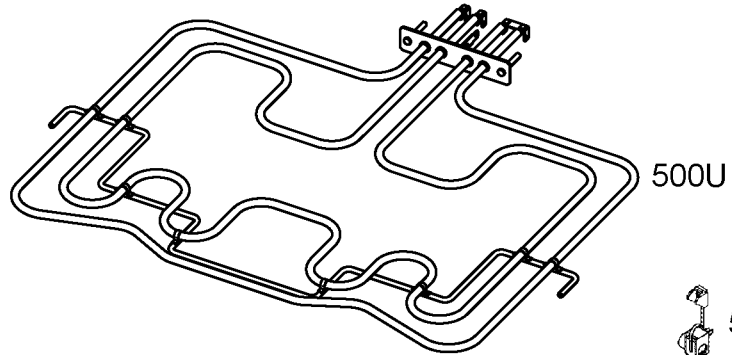

500U



522C

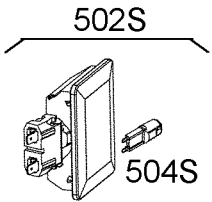

502S

504S

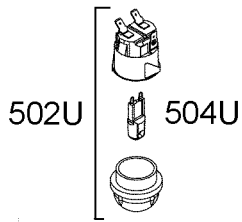

502U

504U

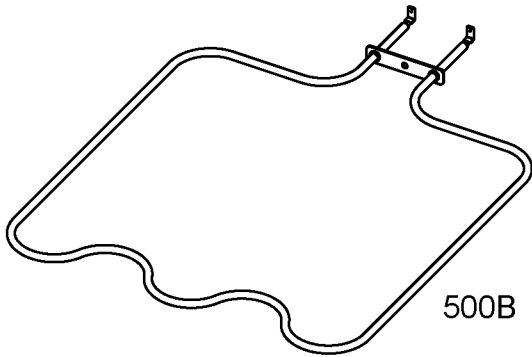

500B

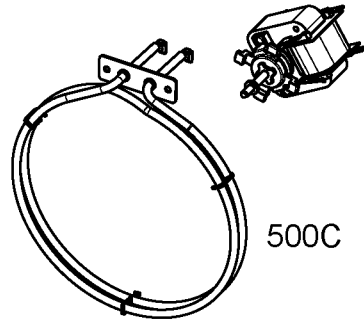

500C

510C



522A

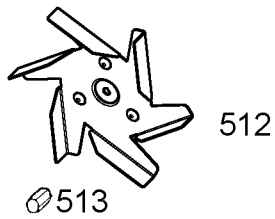

512

513